



RF Feeder System & Accessories

We are at the Heart of All Human Communication





THE WORLD BEST CABLE SOLUTION LEADER

LS Cable & System supplies various cables and materials used for power grids and communication networks around the world across all industries providing its top class technology and excellent quality. The company has also developed state of the art products, such as superconductors, HVDC and submarine cables that will lead the future energy industry.

LS spun off from LG in 2003 as a group specializing in electronics, electrical systems, energy and materials.



LS Cable & System

Transmission Cable
Distribution Cable
Submarine Cable
Telecommunication Cable
Industrial Cable
Industrial Material

LSELECTRIC

Electric &
Automatic Equipments

LS-Nikko Copper

Copper Refinement

LS Mitron

Mechanical &
Electronic Parts

yesco
LNG

E1
LPG

GBON
Power &
Communication
Cables





Contents

LS RF Total Solution for Wireless Base Station, In building System

LS Cable & System, a global supplier in the wire & cable sector, is now expanding its product portfolio on the wireless communication field to provide total-package solution. With years of experience serving in one of the most advanced market in the world, LS Cable & System has capability to implement the most efficient solutions based on state of the art technologies on hand, LS Cable & System is now a RF Total Solution provider to support our customers to meet sophisticated demand of today's fast-evolving technology of wireless communications. We are determined to support our customers with our leading solution technologies.

Transmission Line Products

RF Feeder Cables

ULL Series	6
LHF Series	8
HFC Series	10
HFSC Series	12
RFCX Series	14
Aluminum RFACX Series	16
RFCL Series	18
HFAC Series	20
HFASC Series	22
Jacket Option	24
Packing Information	25
Conversion Table	26

Accessories

Connector	28
Jumpers	33
Accessories	35

In-Building Solutions

In-Building Passive Product

Splitter/Tapper	52
Coupler	55
Combiner	58
Hybrid Combiner	61
POI	

ULL Series

Ultimate Low Loss Flexible Foam Dielectric Feeder



7/8" LHF 22D-U / LHF-FR 22D-U



1-5/8" LHF 42D-U / LHF-FR 42D-U

Construction

		LHF 22D-U (7/8")	LHF 42D-U (1-5/8")
Inner Conductor	Material / Construction	Smooth Copper Tube	Helically Corrugated Copper Tube
	Diameter (mm)	9.5	18.1
Dielectric	Material / Construction	Foamed Polyethylene	Foamed Polyethylene
	Diameter (mm)	23.1	43.6
Outer Conductor	Material / Construction	Annularly Corrugated Copper Tube	Annularly Corrugated Copper Tube
	Diameter (mm)	25.3	46.6
Jacket Diameter	Standard Jacket (mm)	28.2	50.0
	Halogen-Free / Flame-Retardant Jacket (mm)	28.2	50.0

Mechanical Characteristics

		LHF 22D-U (7/8")	LHF 42D-U (1-5/8")
Min. Bending Radius (mm)		250	500
Recommended Operating Temperature	Standard Jacket (°C)	-40 ~ +80	-40 ~ +80
	Halogen-Free / Flame-Retardant Jacket (°C)	-30 ~ +80	-30 ~ +80
Nominal Weight	Standard Jacket (kg/m)	0.47	1.05
	Halogen-Free / Flame-Retardant Jacket (kg/m)	0.51	1.15
Flat Plate Crush Resistance (kg/mm)		1.4	1.6
Max. Pulling Force (kg)		147	181

* ULL series is upgraded version of LHF with superior attenuation characteristics

Electrical Characteristics

		LHF 22D-U (7/8")	LHF 42D-U (1-5/8")
DC Resistance (Ω/1,000m / Ω/1,000ft)	Inner Conductor	1.5 (0.5)	1.4 (0.4)
	Outer Conductor	1.9 (0.6)	0.6 (0.2)
Insulation Resistance (MΩ · km)		10,000	10,000
Dielectric Strength (for 1 Min.)		DC 6,000V	DC 11,000V
Velocity of Propagation (%)		91	92
Peak Power Rating (kW)		91	302
Max. Operating Frequency (GHz)		5.0	2.5
Characteristic Impedance (Ω)		50 ±1	50 ±1
Return Loss (Typical Value) (dB)		28	28

Attenuation(at 20 °C) & Average Power Rating(at Ambient 40°C, Inner Conductor 100°C)

		LHF 22D-U (7/8")	LHF 42D-U (1-5/8")
Attenuation dB/100m (dB/100ft)	Frequency(MHz)		
	30	0.60 (0.18)	0.35 (0.10)
	100	1.11 (0.34)	0.65 (0.20)
	150	1.37 (0.42)	0.80 (0.24)
	450	2.44 (0.74)	1.44 (0.44)
	824	3.38 (1.03)	2.02 (0.61)
	894	3.53 (1.08)	2.11 (0.64)
	960	3.67 (1.12)	2.20 (0.67)
	1,000	3.76 (1.15)	2.25 (0.69)
	1,700	5.04 (1.54)	3.05 (0.93)
	1,800	5.21 (1.59)	3.16 (0.96)
	2,000	5.52 (1.68)	3.36 (1.02)
	2,400	6.13 (1.87)	3.74 (1.14)
	2,700	6.55 (2.00)	-
	3,000	6.96 (2.12)	-
3,500	7.62 (2.32)	-	
4,000	8.23 (2.51)	-	
5,000	9.40 (2.86)	-	
Average Power Rating (kW)	30	11.73	25.98
	100	6.36	13.95
	150	5.16	11.28
	450	2.92	6.26
	824	2.12	4.49
	894	2.03	4.29
	960	1.95	4.12
	1,000	1.91	3.55
	1,700	1.44	2.97
	1,800	1.39	2.88
	2,000	1.31	2.70
	2,400	1.19	2.43
	2,700	1.11	-
	3,000	1.05	-
	3,500	0.96	-
4,000	0.89	-	
5,000	0.79	-	

* Attenuation is typical value

* Standard Conditions : V.S.W.R 1.0 ; Ambient Temperature 20 °C

* Specifications Subject to change without notice

LHF Series

Low Loss Flexible Foam Dielectric Feeder



Construction

		LHF 12D (1/2")	LHF 22D (7/8")	LHF 33D (1-1/4")	LHF 42D (1-5/8")
Inner Conductor	Material / Construction	Copper-Clad Aluminum Wire	Smooth Copper Tube	Smooth Copper Tube	Helically Corrugated Copper Tube
	Diameter (mm)	5.0	9.4	13.7	18.1
Dielectric	Material / Construction	Foamed Polyethylene	Foamed Polyethylene	Foamed Polyethylene	Foamed Polyethylene
	Diameter (mm)	12.5	23.0	33.6	43.5
Outer Conductor	Material / Construction	Annularly Corrugated Copper Tube	Annularly Corrugated Copper Tube	Annularly Corrugated Copper Tube	Annularly Corrugated Copper Tube
	Diameter (mm)	14.2	25.2	36.4	46.5
Jacket Diameter	Standard Jacket (mm)	16.4	28.2	39.4	50.0
	Halogen-Free / Flame-Retardant Jacket (mm)	16.4	28.2	39.4	50.0

Mechanical Characteristics

		LHF 12D (1/2")	LHF 22D (7/8")	LHF 33D (1-1/4")	LHF 42D (1-5/8")
Min. Bending Radius (mm)		125	250	380	500
Recommended Operating Temperature	Standard Jacket (°C)	-40 ~ +80	-40 ~ +80	-40 ~ +80	-40 ~ +80
	Halogen-Free / Flame-Retardant Jacket (°C)	-30 ~ +80	-30 ~ +80	-30 ~ +80	-30 ~ +80
Nominal Weight	Standard Jacket (kg/m)	0.23	0.46	0.84	1.09
	Halogen-Free / Flame-Retardant Jacket (kg/m)	0.25	0.51	0.91	1.19
Flat Plate Crush Resistance (kg/mm)		2.0	1.4	2.4	1.6
Max. Pulling Force (kg)		113	147	260	181

Electrical Characteristics

		LHF12D (1/2")	LHF22D (7/8")	LHF33D (1-1/4")	LHF42D (1-5/8")
DC Resistance (Ω/1,000m / Ω/1,000ft)	Inner Conductor	1.6 (0.5)	1.5 (0.5)	1.1 (0.3)	1.4 (0.4)
	Outer Conductor	1.9 (0.6)	1.9 (0.6)	1.0 (0.3)	0.6 (0.2)
Insulation Resistance (MΩ · km)		10,000	10,000	10,000	10,000
Dielectric Strength (for 1 Min.)		DC 4,000V	DC 6,000V	DC 10,000V	DC 11,000V
Velocity of Propagation (%)		89	89	89	89
Peak Power Rating (kW)		40	91	200	302
Max. Operating Frequency (GHz)		8.8	4.9	3.3	2.5
Characteristic Impedance (Ω)		50	50	50	50
Return Loss (Typical Value) (dB)		28	28	28	28

Attenuation(at 20 °C) & Average Power Rating(at Ambient 40°C, Inner Conductor 100°C)

		Frequency(MHz)	LHF 12D (1/2")	LHF 22D (7/8")	LHF 33D (1-1/4")	LHF 42D (1-5/8")
Attenuation (dB/100m / dB/100ft)	30	1.14 (0.35)	0.59 (0.18)	0.42 (0.13)	0.33 (0.10)	
	100	2.12 (0.65)	1.13 (0.34)	0.79 (0.24)	0.64 (0.20)	
	150	2.60 (0.79)	1.40 (0.43)	0.98 (0.30)	0.80 (0.24)	
	450	4.58 (1.40)	2.52 (0.77)	1.78 (0.54)	1.48 (0.45)	
	824	6.31 (1.92)	3.51 (1.07)	2.51 (0.77)	2.11 (0.64)	
	894	6.55 (2.00)	3.67 (1.12)	2.64 (0.81)	2.20 (0.67)	
	960	6.84 (2.08)	3.82 (1.16)	2.75 (0.84)	2.31 (0.70)	
	1,000	7.00 (2.13)	3.92 (1.19)	2.79 (0.85)	2.38 (0.73)	
	1,700	9.32 (2.84)	5.29 (1.61)	3.84 (1.17)	3.28 (1.00)	
	1,800	9.61 (2.93)	5.47 (1.67)	3.97 (1.21)	3.40 (1.04)	
	2,000	10.19 (3.11)	5.81 (1.77)	4.25 (1.30)	3.63 (1.11)	
	2,400	11.10 (3.38)	6.46 (1.97)	4.73 (1.44)	4.05 (1.23)	
	2,700	12.53 (3.73)	6.88 (2.10)	5.11 (1.56)	4.18 (1.27)	
	3,000	12.96 (3.95)	7.37 (2.25)	5.43 (1.66)	-	
	3,500	13.92 (4.24)	8.08 (2.46)	-	-	
4,000	15.27 (4.65)	8.75 (2.67)	-	-		
5,000	17.15 (5.23)	9.99 (3.04)	-	-		
Average Power Rating (kW)	30	6.10	13.58	21.30	30.60	
	100	3.32	7.36	11.50	16.42	
	150	2.71	5.98	9.32	13.28	
	450	1.55	3.38	5.23	7.37	
	824	1.13	2.46	3.78	5.28	
	894	1.09	2.36	3.61	5.05	
	960	1.05	2.27	3.48	4.85	
	1,000	1.03	2.22	3.40	4.74	
	1,700	0.78	1.67	2.53	3.50	
	1,800	0.76	1.62	2.45	3.39	
	2,000	0.71	1.53	2.31	3.18	
	2,400	0.65	1.38	2.09	2.86	
	2,700	0.61	1.31	1.95	2.77	
	3,000	0.58	1.22	1.84	-	
	3,500	0.53	1.12	-	-	
4,000	0.50	1.04	-	-		
5,000	0.44	0.92	-	-		

* Attenuation is typical value
 * Standard Conditions : V.S.W.R 1.0 ; Ambient Temperature 20 °C
 * Specifications Subject to change without notice

HFC Series

Flexible Foam Dielectric Feeder



1/2 " HFC 12D / HFC-FR 12D



7/8 " HFC 22D / HFC-FR 22D



1-1/4 " HFC 33D / HFC-FR 33D



1-5/8 " HFC 42D / HFC-FR 42D

Construction

		HFC 12D (1/2")	HFC 22D (7/8")	HFC 33D (1-1/4")	HFC 42D (1-5/8")
Inner Conductor	Material / Construction	Copper-Clad Aluminum Wire	Smooth Copper Tube	Smooth Copper Tube	Helically Corrugated Copper Tube
	Diameter (mm)	4.8	9.0	13.1	17.2
Dielectric	Material / Construction	Foamed Polyethylene	Foamed Polyethylene	Foamed Polyethylene	Foamed Polyethylene
	Diameter (mm)	12.0	22.1	32.5	42.5
Outer Conductor	Material / Construction	Annularly Corrugated Copper Tube	Annularly Corrugated Copper Tube	Annularly Corrugated Copper Tube	Annularly Corrugated Copper Tube
	Diameter (mm)	13.8	24.9	36.0	46.5
Jacket Diameter	Standard Jacket (mm)	16.0	27.9	39.0	50.0
	Halogen-Free / Flame-Retardant Jacket (mm)	16.0	27.9	39.0	50.0

Mechanical Characteristics

		HFC 12D (1/2")	HFC 22D (7/8")	HFC 33D (1-1/4")	HFC 42D (1-5/8")
Min. Bending Radius (mm)		125	250	380	500
Recommended Operating Temperature	Standard Jacket (°C)	-40 ~ +80	-40 ~ +80	-40 ~ +80	-40 ~ +80
	Halogen-Free / Flame-Retardant Jacket (°C)	-30 ~ +80	-30 ~ +80	-30 ~ +80	-30 ~ +80
Nominal Weight	Standard Jacket (kg/m)	0.23	0.48	0.87	1.13
	Halogen-Free / Flame-Retardant Jacket (kg/m)	0.25	0.53	0.94	1.23
Flat Plate Crush Resistance (kg/mm)		2.0	1.4	2.4	2.7
Max. Pulling Force (kG)		113	147	260	250

Electrical Characteristics

		HFC 12D (1/2")	HFC 22D (7/8")	HFC 33D (1-1/4")	HFC 42D (1-5/8")
DC Resistance (Ω/1,000m (Ω/1,000ft))	Inner Conductor	1.6 (0.5)	1.3 (0.4)	0.8 (0.2)	0.9 (0.3)
	Outer Conductor	2.3 (0.7)	1.4 (0.4)	0.7 (0.2)	0.6 (0.2)
Insulation Resistance (MΩ · km)		10,000	10,000	10,000	10,000
Dielectric Strength (for 1 Min.)		DC 4,000V	DC 6,000V	DC 9,000V	DC 11,000V
Velocity of Propagation (%)		88	88	88	88
Peak Power Rating (kW)		40	91	205	315
Max. Operating Frequency (GHz)		8.8	5.0	3.3	2.5
Characteristic Impedance (Ω)		50	50	50	50
Return Loss (Typical Value) (dB)		28	28	28	28

Attenuation(at 20 °C) & Average Power Rating(at Ambient 40°C, Inner Conductor 100°C)

		HFC 12D (1/2")	HFC 22D (7/8")	HFC 33D (1-1/4")	HFC 42D (1-5/8")
Attenuation dB/100m (dB/100ft)	30	1.17 (0.36)	0.64 (0.20)	0.44 (0.13)	0.36 (0.11)
	100	2.17 (0.66)	1.19 (0.36)	0.83 (0.25)	0.67 (0.20)
	150	2.67 (0.81)	1.47 (0.45)	1.03 (0.31)	0.84 (0.26)
	450	4.75 (1.45)	2.65 (0.81)	1.86 (0.57)	1.53 (0.47)
	824	6.49 (1.98)	3.68 (1.12)	2.62 (0.80)	2.17 (0.66)
	890	6.76 (2.06)	3.85 (1.17)	2.75 (0.84)	2.27 (0.69)
	960	7.04 (2.15)	4.01 (1.22)	2.86 (0.87)	2.38 (0.73)
	1,000	7.20 (2.19)	4.10 (1.25)	2.94 (0.90)	2.43 (0.74)
	1,700	9.61 (2.93)	5.54 (1.69)	4.01 (1.22)	3.35 (1.02)
	1,800	9.91 (3.02)	5.73 (1.75)	4.15 (1.26)	3.47 (1.06)
	2,000	10.70 (3.26)	6.09 (1.86)	4.43 (1.35)	3.71 (1.13)
	2,300	11.54 (3.52)	6.63 (2.02)	4.60 (1.40)	4.07 (1.24)
	2,700	12.61 (3.84)	7.30 (2.13)	5.11 (1.56)	4.53 (1.38)
	3,000	13.44 (4.10)	7.81 (2.38)	5.43 (1.66)	-
3,400	14.44 (4.40)	8.52 (2.60)	-	-	
4,000	15.81 (4.82)	9.42 (2.87)	-	-	
5,000	17.77 (5.42)	10.84 (3.30)	-	-	
Average Power Rating (kW)	30	6.19	13.90	21.33	29.55
	100	3.36	7.51	11.36	15.60
	150	2.74	6.09	9.15	12.52
	450	1.56	3.43	5.02	6.76
	824	1.14	2.48	3.56	4.74
	890	1.10	2.38	3.40	4.52
	960	1.05	2.28	3.26	4.32
	1,000	1.03	2.23	3.18	4.22
	1,700	0.78	1.67	2.32	3.04
	1,800	0.76	1.62	2.24	2.93
	2,000	0.72	1.52	2.10	2.74
	2,300	0.66	1.41	1.93	2.51
	2,700	0.62	1.33	1.74	2.25
	3,000	0.58	1.21	1.64	-
3,400	0.54	1.13	-	-	
4,000	0.49	1.03	-	-	
5,000	0.44	0.90	-	-	

* Attenuation is typical value

* Standard Conditions : V.S.W.R 1.0 ; Ambient Temperature 20 °C

* Specifications Subject to change without notice

HFSC Series

Super Flexible Foam Dielectric Feeder



Construction

		HFSC 6D (1/4")	HFSC 10D (3/8")	HFSC 12D (1/2")	HFSC 22D (7/8")
Inner Conductor	Material / Construction	Copper-Clad Aluminum Wire	Copper-Clad Aluminum Wire	Copper-Clad Aluminum Wire	Helically Corrugated Copper Tube
	Diameter (mm)	1.9	2.8	3.6	9.4
Dielectric	Material / Construction	Foamed Polyethylene	Foamed Polyethylene	Foamed Polyethylene	Foamed Polyethylene
	Diameter (mm)	4.7	7.2	8.9	23.0
Outer Conductor	Material / Construction	Annularly Corrugated Copper Tube	Annularly Corrugated Copper Tube	Annularly Corrugated Copper Tube	Annularly Corrugated Copper Tube
	Diameter (mm)	6.4	9.5	12.2	25.2
Jacket Diameter	Standard Jacket (mm)	7.5	10.5	13.6	27.9
	Halogen-Free / Flame-Retardant Jacket (mm)	7.5	10.5	13.6	27.9

Mechanical Characteristics

		HFSC 6D (1/4")	HFSC 10D (3/8")	HFSC 12D (1/2")	HFSC 22D (7/8")
Min. Bending Radius (mm)		25	25	32	125
Recommended Operating Temperature	Standard Jacket (°C)	-40 ~ +80	-40 ~ +80	-40 ~ +80	-40 ~ +80
	Halogen-Free / Flame-Retardant Jacket (°C)	-30 ~ +80	-30 ~ +80	-30 ~ +80	-30 ~ +80
Nominal Weight	Standard Jacket (kg/m)	0.06	0.11	0.18	0.44
	Halogen-Free / Flame-Retardant Jacket (kg/m)	0.07	0.12	0.19	0.50
Flat Plate Crush Resistance (kg/mm)		1.86	1.7	1.7	1.4
Max. Pulling Force (kg)		68	60	65	102

Electrical Characteristics

		HFSC 6D (1/4")	HFSC 10D (3/8")	HFSC 12D (1/2")	HFSC 22D (7/8")
DC Resistance (Ω/1,000m / Ω/1,000ft)	Inner Conductor	9.80 (2.99)	4.20 (1.28)	2.85 (0.87)	3.00 (0.91)
	Outer Conductor	6.50 (1.98)	5.00 (1.52)	3.75 (1.14)	1.40 (0.43)
Insulation Resistance (MΩ · km)		10,000	10,000	10,000	10,000
Dielectric Strength (for 1 Min.)		DC 1,600V	DC 2,300V	DC 2,500V	DC 6,000V
Velocity of Propagation (%)		81	81	81	88
Peak Power Rating (kW)		6.4	13.2	15.6	90
Max. Operating Frequency (GHz)		20.4	13.0	10.0	5.0
Characteristic Impedance (Ω)		50	50	50	50
Return Loss (Typical Value) (dB)		28	28	28	28

Attenuation (at 20°C) & Average Power Rating (at Ambient 40°C, Inner Conductor 100°C)

Frequency (MHz)		HFSC 6D (1/4")	HFSC 10D (3/8")	HFSC 12D (1/2")	HFSC 22D (7/8")
Attenuation (dB/100m / dB/100ft)	30	3.15 (0.96)	2.28 (0.69)	1.80 (0.55)	0.70 (0.21)
	100	5.82 (1.77)	4.22 (1.29)	3.33 (1.01)	1.29 (0.39)
	150	7.17 (2.19)	5.20 (1.58)	4.10 (1.25)	1.61 (0.49)
	450	12.70 (3.87)	9.22 (2.81)	7.29 (2.22)	2.85 (0.87)
	824	17.60 (5.36)	12.70 (3.87)	10.10 (3.08)	3.97 (1.21)
	894	18.40 (5.61)	13.30 (4.05)	10.50 (3.20)	4.12 (1.26)
	960	19.10 (5.82)	13.80 (4.21)	11.00 (3.35)	4.32 (1.32)
	1,000	19.50 (5.94)	14.10 (4.30)	11.20 (3.41)	4.42 (1.35)
	1,700	26.10 (7.96)	18.80 (5.73)	15.00 (4.57)	5.95 (1.81)
	1,800	26.90 (8.20)	19.40 (5.91)	15.50 (4.72)	6.13 (1.87)
	2,000	28.50 (8.69)	20.60 (6.28)	16.40 (5.00)	6.52 (1.99)
	2,400	31.60 (9.63)	22.80 (6.95)	18.20 (5.55)	7.13 (2.17)
	3,000	35.80 (10.91)	25.80 (7.86)	20.70 (6.31)	8.27 (2.52)
	4,000	42.20 (12.86)	30.40 (9.27)	24.40 (7.44)	9.80 (2.99)
	6,000	53.40 (16.28)	38.40 (11.70)	31.00 (9.45)	-
	10,000	72.60 (22.13)	52.10 (15.90)	42.30 (12.89)	-
14,000	89.40 (27.25)	-	-	-	
16,000	97.20 (29.63)	-	-	-	
Average Power Rating (kW)	30	2.08	3.44	4.87	14.32
	100	1.13	1.86	2.62	7.72
	150	0.92	1.51	2.12	6.26
	450	0.52	0.85	1.19	3.51
	824	0.38	0.61	0.85	2.53
	894	0.36	0.59	0.82	2.42
	960	0.35	0.57	0.79	2.33
	1,000	0.34	0.55	0.77	2.28
	1,700	0.26	0.41	0.57	1.70
	1,800	0.25	0.40	0.55	1.65
	2,000	0.24	0.38	0.52	1.55
	2,400	0.22	0.34	0.47	1.40
	3,000	0.19	0.30	0.41	1.23
	4,000	0.16	0.26	0.35	1.04
	6,000	0.13	0.20	0.27	-
	10,000	0.10	0.15	0.20	-
14,000	0.08	-	-	-	
16,000	0.08	-	-	-	

* Attenuation is typical value

* Standard Conditions : V.S.W.R 1.0 ; Ambient Temperature 20 °C

* Specifications Subject to change without notice

Radiating Cable RFCX Series(Coupled Mode)



Construction

		RFCX 12D (1/2")	RFCX 22D (7/8")	RFCX 33D (1-1/4")	RFCX 42D (1-5/8")
Inner Conductor	Material / Construction	Copper-Clad Aluminum Wire	Smooth Copper Tube	Smooth Copper Tube	Helicly Corrugated Copper Tube
	Diameter (mm)	4.8	9.0	13.1	17.2
Dielectric	Material / Construction	Foamed Polyethylene	Foamed Polyethylene	Foamed Polyethylene	Foamed Polyethylene
	Diameter (mm)	12.0	22.1	32.5	42.5
Outer Conductor	Material / Construction	Annularly Corrugated Copper Tube with Milled Slots	Annularly Corrugated Copper Tube with Milled Slots	Annularly Corrugated Copper Tube with Milled Slots	Annularly Corrugated Copper Tube with Milled Slots
	Diameter (mm)	13.8	24.9	36.0	46.5
Jacket Diameter	Standard Jacket (mm)	16.0	27.9	39.0	50.0
	Halogen-Free / Flame-Retardant Jacket (mm)	16.0	27.9	39.0	50.0

Mechanical Characteristics

		RFCX 12D (1/2")	RFCX 22D (7/8")	RFCX 33D (1-1/4")	RFCX 42D (1-5/8")
Min. Bending Radius (mm)		125	250	380	500
Recommended Operating Temperature	Standard Jacket (°C)	-40 ~ +80	-40 ~ +80	-40 ~ +80	-40 ~ +80
	Halogen-Free / Flame-Retardant Jacket (°C)	-30 ~ +80	-30 ~ +80	-30 ~ +80	-30 ~ +80
Nominal Weight	Standard Jacket (kg/m)	0.22	0.48	0.87	1.12
	Halogen-Free / Flame-Retardant Jacket (kg/m)	0.24	0.52	0.93	1.22

Electrical Characteristics

		RFCX 12D (1/2")	RFCX 22D (7/8")	RFCX 33D (1-1/4")	RFCX 42D (1-5/8")
DC Resistance (Ω/1,000m / Ω/1,000ft)	Inner Conductor	1.55 (0.47)	1.30 (0.43)	0.80 (0.24)	0.85 (0.26)
	Outer Conductor	3.00 (0.91)	1.90 (0.58)	0.90 (0.27)	0.90 (0.28)
Insulation Resistance (MΩ · km)		10,000	10,000	10,000	10,000
Dielectric Strength (for 1 Min.)		DC 4,000V	DC 6,000V	DC 9,000V	DC 11,000V
Velocity of Propagation (%)		88	88	88	87
Characteristic Impedance (Ω)		50	50	50	50

Attenuation (at 20°C) & Average Power Rating (at Ambient 40°C, Inner Conductor 100°C)

Frequency (MHz)		RFCX 12D (1/2")	RFCX 22D (7/8")	RFCX 33D (1-1/4")	RFCX 42D (1-5/8")
Attenuation (dB/100m)	75	2.2	1.2	1.0	0.75
	150	3.1	1.6	1.3	0.95
	450	5.5	2.9	2.4	1.9
	800	7.5	4.8	3.4	2.6
	900	7.9	4.9	3.6	2.8
	1,800	11.8	7.5	5.9	4.3
	2,200	13.1	8.8	7.1	5.5
	2,400	14.0	9.0	8.1	5.8
Coupling Loss (dB, 50% / 95%)	75	63/74	59/69	61/71	63/74
	150	67/77	66/77	70/77	72/81
	450	71/83	70/80	77/90	76/86
	800	75/86	70/82	77/89	76/87
	900	74/85	69/79	77/86	76/88
	1,800	71/82	67/81	74/85	73/81
	2,200	73/84	69/80	74/85	80/91
	2,400	71/83	69/82	76/87	79/90

* Attenuation is typical value

* Specifications Subject to change without notice

Radiating Cable

Aluminum RFACX Series(Coupled Mode)



Construction

		RFACX 12D (1/2")	RFACX 22D (7/8")
Inner Conductor	Material / Construction	Copper-Clad Aluminum Wire	Smooth Copper Tube
	Diameter (mm)	4.8	9.4
Dielectric	Material / Construction	Foamed Polyethylene	Foamed Polyethylene
	Diameter (mm)	12.0	23.0
Outer Conductor	Material / Construction	Annularly Corrugated Aluminum Tube with Milled Slots	Annularly Corrugated Aluminum Tube with Milled Slots
	Diameter (mm)	13.8	25.2
Jacket Diameter	Standard Jacket (mm)	16.0	28.2
	Halogen-Free / Flame-Retardant Jacket (mm)	16.0	28.2

Mechanical Characteristics

		RFACX 12D (1/2")	RFACX 22D (7/8")
Min. Bending Radius (mm)		125	250
Recommended Operating Temperature	Standard Jacket (°C)	-40 ~ +80	-40 ~ +80
	Halogen-Free / Flame-Retardant Jacket (°C)	-30 ~ +80	-30 ~ +80
Nominal Weight	Standard Jacket (kg/m)	0.17	0.38
	Halogen-Free / Flame-Retardant Jacket (kg/m)	0.19	0.42

Electrical Characteristics

		RFACX 12D (1/2")	RFACX 22D (7/8")
DC Resistance Ω /1,000m (Ω /1,000ft)	Inner Conductor	1.55 (0.47)	1.50 (0.45)
	Outer Conductor	3.00 (0.91)	1.70 (0.52)
Insulation Resistance (M Ω · km)		10,000	10,000
Dielectric Strength (for 1 Min.)		DC 4,000V	DC 6,000V
Velocity of Propagation (%)		88	88
Characteristic Impedance (Ω)		50	50

Attenuation (at 20°C) & Average Power Rating (at Ambient 40°C, Inner Conductor 100°C)

		RFACX 12D (1/2")	RFACX 22D (7/8")
Attenuation (dB/100m)	Frequency (MHz)		
	75	2.2	1.3
	150	3.1	1.8
	450	5.5	3.0
	800	7.5	4.9
	900	7.9	5.2
	1,800	11.8	7.6
	2,200	13.1	8.8
Coupling Loss (dB, 50% / 95%)	Frequency (MHz)		
	75	63 / 74	59 / 69
	150	67 / 77	66 / 77
	450	71 / 83	70 / 80
	800	75 / 86	70 / 82
	900	74 / 85	69 / 79
	1,800	71 / 82	67 / 81
	2,200	73 / 84	69 / 80
2,400	71 / 83	69 / 82	

* Attenuation is typical value
 * Specifications Subject to change without notice

Radiating Cable

RFCL Series(Radiating Mode)



Construction

		RFCL 22D (7/8")	RFCL 33D (1-1/4")	RFCL 42D (1-5/8")
Inner Conductor	Material / Construction	Smooth Copper Tube	Smooth Copper Tube	Helically Corrugated Copper Tube
	Diameter (mm)	9.0	13.0	17.1
Dielectric	Material / Construction	Foamed Polyethylene	Foamed Polyethylene	Foamed Polyethylene
	Diameter (mm)	23.3	33.0	43.5
Outer Conductor	Material / Construction	Overlapped Copper Foil with Punched Leaky Slots	Overlapped Copper Foil with Punched Leaky Slots	Overlapped Copper Foil with Punched Leaky Slots
	Diameter (mm)	23.7	33.5	45.5
Jacket Diameter	Standard Jacket (mm)	29.7	38.0	50.6
	Halogen-Free / Flame-Retardant Jacket (mm)	29.7	39.0	50.6

Mechanical Characteristics

		RFCL 22D (7/8")	RFCL 33D (1-1/4")	RFCL 42D (1-5/8")
Min. Bending Radius (mm)		350	500	700
Recommended Operating Temperature	Standard Jacket (°C)	-40 ~ +80	-40 ~ +80	-40 ~ +80
	Halogen-Free / Flame-Retardant Jacket (°C)	-30 ~ +80	-30 ~ +80	-30 ~ +80
Nominal Weight	Standard Jacket (kg/m)	0.61	0.88	1.01
	Halogen-Free / Flame-Retardant Jacket (kg/m)	0.71	0.99	1.15

Electrical Characteristics

		RFCL 22D (7/8")	RFCL 33D (1-1/4")	RFCL 42D (1-5/8")
DC Resistance (Ω/1,000m (Ω/1,000ft))	Inner Conductor	1.50 (0.46)	1.50 (0.46)	1.50 (0.46)
	Outer Conductor	2.00 (0.61)	2.30 (0.70)	2.00 (0.61)
Insulation Resistance (MΩ · km)		10,000	10,000	10,000
Dielectric Strength (for 1 Min.)		DC 6,000V	DC 9,000V	DC 11,000V
Velocity of Propagation (%)		88	87	87
Characteristic Impedance (Ω)		50	50	50

Attenuation (at 20°C) & Average Power Rating (at Ambient 40°C, Inner Conductor 100°C)

	Frequency (MHz)	RFCL 22D (7/8")		RFCL 33D (1-1/4")		RFCL 42D (1-5/8")	
		Attenuation	Coupling Loss	Attenuation	Coupling Loss	Attenuation	Coupling Loss
		(dB/100m)	50% / 95%	(dB/100m)	50% / 95%	(dB/100m)	50% / 95%
RFCL M-Type	75	1.1	79/86	0.8	71/81	0.7	70/80
	150	1.5	77/83	1.1	76/85	0.9	70/80
	450	3.0	84/89	2.1	73/80	1.6	62/67
	800	4.0	63/73	3.3	64/72	2.6	65/70
	900	4.3	65/75	3.6	64/70	2.8	65/70
RFCL W-Type	1,700	5.9	63/68	5.5	56/61	5.8	58/63
	1,900	6.2	64/69	5.9	62/67	6.3	56/61
	2,100	6.5	64/69	6.3	69/64	7.1	58/63
	2,300	7.0	65/70	6.7	60/65	8.6	60/65
	2,400	7.3	65/70	7.8	60/65	9.6	60/65

* Attenuation is typical value
* Specifications Subject to change without notice

HFAC Series

Flexible Foam Dielectric Aluminum Feeder



Construction

		HFAC 12D (1/2")	HFAC 22D (7/8")	HFAC 33D (1-1/4")	HFAC 42D (1-5/8")
Inner Conductor	Material / Construction	Copper-Clad Aluminum Wire	Smooth Copper Tube	Smooth Copper Tube	Helically Corrugated Copper Tube
	Diameter (mm)	5.0	9.4	13.7	18.1
Dielectric	Material / Construction	Foamed Polyethylene	Foamed Polyethylene	Foamed Polyethylene	Foamed Polyethylene
	Diameter (mm)	12.5	23.0	33.6	43.5
Outer Conductor	Material / Construction	Annularly Corrugated Aluminum Tube	Annularly Corrugated Aluminum Tube	Annularly Corrugated Aluminum Tube	Annularly Corrugated Aluminum Tube
	Diameter (mm)	14.2	25.2	33.6	46.7
Jacket Diameter	Standard Jacket (mm)	16.4	28.2	37.0	50.2
	Halogen-Free / Flame-Retardant Jacket (mm)	16.4	28.2	40.0	50.2

Mechanical Characteristics

		HFAC 12D (1/2")	HFAC 22D (7/8")	HFAC 33D (1-1/4")	HFAC 42D (1-5/8")
Min. Bending Radius (mm)		125	250	380	500
Recommended Operating Temperature	Standard Jacket (°C)	-40 ~ +80	-40 ~ +80	-40 ~ +80	-40 ~ +80
	Halogen-Free / Flame-Retardant Jacket (°C)	-30 ~ +80	-30 ~ +80	-30 ~ +80	-30 ~ +80
Nominal Weight	Standard Jacket (kg/m)	0.18	0.38	0.71	0.93
	Halogen-Free / Flame-Retardant Jacket (kg/m)	0.20	0.43	0.77	1.03
Max. Pulling Force (kg)		113	147	260	181

Electrical Characteristics

		HFAC 12D (1/2")	HFAC 22D (7/8")	HFAC 33D (1-1/4")	HFAC 42D (1-5/8")
DC Resistance (Ω/1,000m) (Ω/1,000ft)	Inner Conductor	1.60 (4.9)	1.50 (0.46)	1.10 (0.46)	1.40 (0.59)
	Outer Conductor	2.50 (0.77)	2.40 (0.74)	1.50 (0.74)	1.00 (0.42)
Insulation Resistance (MΩ · km)		10,000	10,000	10,000	10,000
Dielectric Strength (for 1 Min.)		DC 4,000V	DC 6,000V	DC 9,000V	DC 11,000V
Velocity of Propagation (%)		89	89	89	89
Peak Power Rating (kW)		40	91	200	302
Max. Operating Frequency (GHz)		8.8	5.0	3.3	2.5
Characteristic Impedance (Ω)		50	50	50	50
Return Loss (Typical Value) (dB)		28	28	28	28

Attenuation (at 20°C) & Average Power Rating (at Ambient 40°C, Inner Conductor 100°C)

		Frequency (MHz)	HFAC 12D (1/2")	HFAC 22D (7/8")	HFAC 33D (1-1/4")	HFAC 42D (1-5/8")
Attenuation (dB/100m) (dB/100ft)	30		1.17 (0.36)	0.64 (0.20)	0.47 (0.14)	0.67 (0.21)
	450		4.75 (1.46)	2.65 (0.82)	1.93 (0.59)	1.53 (0.47)
	824		6.49 (2.00)	3.68 (1.13)	2.70 (0.83)	2.17 (0.67)
	890		6.76 (2.08)	3.85 (1.18)	2.82 (0.87)	2.27 (0.70)
	1,700		9.61 (2.96)	5.54 (1.70)	4.11 (1.26)	3.35 (1.03)
	2,000		10.70 (3.30)	6.09 (1.87)	4.56 (1.40)	3.71 (1.14)
	2,300		11.54 (3.55)	6.63 (2.04)	4.85 (1.49)	4.07 (1.25)
Average Power Rating (kW)	30		5.81	12.93	20.29	29.14
	450		1.46	3.30	4.99	7.02
	824		1.07	2.40	3.60	5.03
	890		1.02	2.30	3.44	4.81
	1,700		0.72	1.63	2.41	3.33
	2,000		0.65	1.49	2.20	3.03
2,300		0.60	1.38	2.05	2.57	

* Attenuation is typical value

* Standard Conditions : V.S.W.R 1.0 ; Ambient Temperature 20 °C

* Specifications Subject to change without notice

HFASC Series

Super Flexible Foam Dielectric Aluminum Feeder

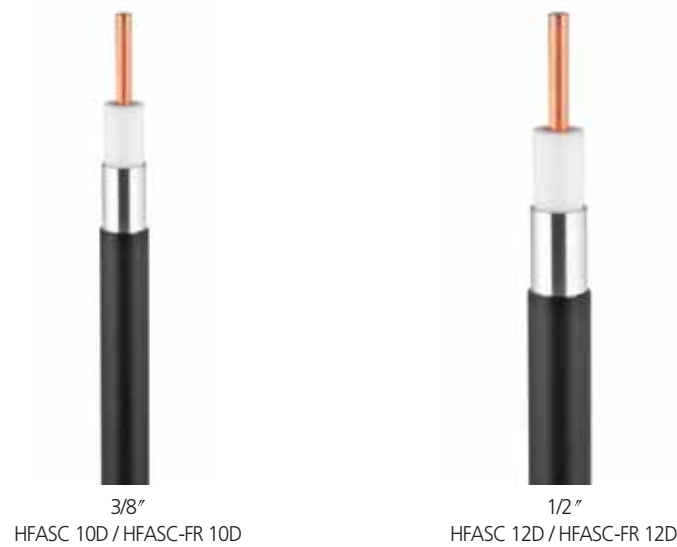

Construction

		HFASC 10D (3/8")	HFASC 12D (1/2")
Inner Conductor	Material / Construction	Copper-Clad Aluminum Wire	Copper-Clad Aluminum Wire
	Diameter (mm)	3.6	5.0
Dielectric	Material / Construction	Foamed Polyethylene	Foamed Polyethylene
	Diameter (mm)	9.7	13.4
Outer Conductor	Material / Construction	Aluminum Smooth Tube	Aluminum Smooth Tube
	Diameter (mm)	10.1	13.8
Jacket Diameter	Standard Jacket (mm)	11.4	15.6
	Halogen-Free / Flame-Retardant Jacket (mm)	11.4	15.6

* Cable dimension is nominal value

Mechanical Characteristics

		HFASC 10D (3/8")	HFASC 12D (1/2")
Min. Bending Radius (mm)		32	60
Recommended Operating Temperature	Standard Jacket (°C)	-40 ~ +80	-40 ~ +80
	Halogen-Free / Flame-Retardant Jacket (°C)	-30 ~ +80	-30 ~ +80
Nominal Weight	Standard Jacket (kg/m)	109	0.18
	Halogen-Free / Flame-Retardant Jacket (kg/m)	117	0.19
Flat Plate Crush Resistance (kg/mm)		1.7	1.7
Max. Pulling Force (kg)		113	182

Electrical Characteristics

		HFASC 10D (3/8")	HFASC 12D (1/2")
DC Resistance (Ω/1,000m) (Ω/1,000ft)	Inner Conductor	3.0 (1.0)	1.8 (0.6)
	Outer Conductor	3.4 (1.1)	2.8 (0.9)
Insulation Resistance (MΩ · km)		10,000	10,000
Dielectric Strength (for 1 Min.)		DC 2,500V	DC 2,500V
Velocity of Propagation (%)		85	88
Peak Power Rating (kW)		15.6	41.8
Max. Operating Frequency (GHz)		12	8.8
Characteristic Impedance (Ω)		50	50
Return Loss (Typical Value) (dB)		28	28

Attenuation (at 20°C) & Average Power Rating (at Ambient 40°C, Inner Conductor 100°C)

		HFASC 10D (3/8")	HFASC 12D (1/2")
Attenuation (dB/100m) (dB/100ft)	Frequency (MHz)		
	100	3.13 (0.95)	2.23 (0.68)
	450	6.94 (2.12)	4.72 (1.44)
	824	9.43 (2.87)	6.46 (1.97)
	894	9.92 (3.02)	6.76 (2.06)
	1,500	13.10 (3.99)	9.45 (2.88)
	1,800	14.38 (4.38)	9.92 (3.02)
	2,000	15.35 (4.68)	10.53 (3.21)
	2,400	16.85 (5.14)	11.65 (3.55)
	Average Power Rating (kW)	100	2.89
450		1.30	1.56
824		0.93	1.13
894		0.89	1.10
1,500		0.66	0.78
1,800		0.60	0.73
2,000		0.55	0.70
2,400		0.50	0.63

* Attenuation is typical value

* Standard Conditions : V.S.W.R 1.0 ; Ambient Temperature 20 °C

* Specifications Subject to change without notice

Jacket Option

Packing Information

Standard Jacket

LHF & HFC & HFSC & HFAC & RFCX & RFACX & RFCL Series Cables Complying with;

- IEC 754-1 : Halogen Acid Gas Content (Chlorine < 0.5%)
- IEC 754-2 : Degree of Acidity of Gas (pH-Value > 4.0, Conductivity < 100 $\mu\text{S/cm}$)

Flame Retardant Jacket

LHF & HFC & HFSC & HFAC & RFCX & RFACX Series Cables Complying with;

- IEC 754-1 : Halogen Acid Gas Content (Chlorine < 0.5%)
- IEC 754-2 : Degree of Acidity of Gas (pH-Value > 4.0, Conductivity < 100 $\mu\text{S/cm}$)
- IEC 332-1 : Flammability Test on Single Cables
- IEC 332-3C : Flammability Test on Cable Bundles
- IEEE 383 : Flammability Test on Cable Bundles
- ASTM E 662 : Optical Density of Smoke (Smoke - Density < 150)

RFCL Series Cables Complying with;

- IEC 754-1 : Halogen Acid Gas Content (Chlorine < 0.5%)
- IEC 754-2 : Degree of Acidity of Gas (pH-Value > 4.0, Conductivity < 100 $\mu\text{S/cm}$)
- IEC 332-1 : Flammability Test on Single Cables
- ASTM E 662 : Optical Density of Smoke (Smoke - Density < 150)

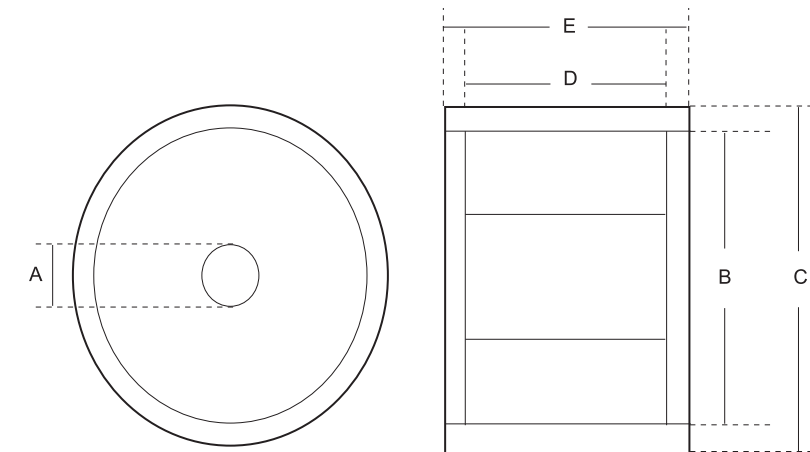

Model	Jacket	IEC 754-1	IEC 754-2	IEC 332-1	IEC 332-3C	IEEE 383	ASTM E 662
<ul style="list-style-type: none"> • LHF 12D / 22D / 32D / 42D • HFC 12D / 22D / 32D / 42D • HFSC 6D / 10D • HFSC 12D / 22D • HFAC 12D / 22D / 32D / 42D • RFCX 12D / 22D / 32D / 42D • RFACX 12D / 22D 	Standard Black PE	○	○	—	—	—	—
<ul style="list-style-type: none"> • RFCL 22D / 33D / 42D 	Standard Black PE	○	○	—	—	—	—
<ul style="list-style-type: none"> • LHF-FR 12D / 22D / 33D / 42D • HFC-FR 12D / 22D / 33D / 42D • HFSC-FR 6D / 10D / 12D / 22D • HFAC-FR 12D / 22D / 33D / 42D • RFCX-FR 12D / 22D / 33D / 42D • RFACX-FR 12D / 22D 	Halogen-Free Flame-Retardant Black Compound	○	○	○	○	○	○
<ul style="list-style-type: none"> • RFCL-FR 22D / 33D / 42D 	Halogen-Free Flame-Retardant Black Compound	○	○	○	—	—	○

Size	Model	Standard (m)	Drum Type					Drum Weight (kg)	Quantity of Drums Per Container		
			A	B	C	D	E		20 ft	40 ft	40 ft HQ
1-5/8"	LHF(-FR) 42D	500	110	2,100	2,160	1,020	1,200	485	5	10	10
	HFC(-FR) 42D										
1-1/4"	HFC(-FR) 33D	500	110	1,700	1,760	750	900	250	6	13	13
	RFCX(-FR) 33D										
7/8"	HFC(-FR) 22D	500	110	1,200	1,260	650	750	160	12	25	45
	RFCX(-FR) 22D										
1/2"	HFC(-FR) 12D	500	75	850	900	428	500	70	44	100	100
	RFCX(-FR) 12D										
1/2" SF	HFC(-FR) 12D	500	75	850	870	428	500	65	44	100	100
	HFC(-FR) 12D										
1/2"	HFC(-FR) 12D	500	75	860	910	430	470	45	44	100	100
3/8"	HFC(-FR) 10D	500	85	860	910	430	470	45	44	100	100

Conversion Table

The reflection coefficient sums up the effects of all the impedance variations within the cable and its end at a certain frequency.

"Return Loss" or "V.S.W.R." is usually used instead of reflection coefficient.

The following formulas can be used for converting among the "Return Loss", "Reflection Coefficient" and "V.S.W.R."

$$V.S.W.R = \frac{1 + |\Gamma|}{1 - |\Gamma|} \quad \text{Reflection Coefficient } (\Gamma) = \frac{Z_L - Z_0}{Z_L + Z_0} = \frac{Z_n - 1}{Z_n + 1} \quad \left(Z_n = \frac{Z_L}{Z_0} \right)$$

$$R.L. (\text{Return Loss}) = -20 \log (|\Gamma|)$$

V.S.W.R	Return Loss (dB)	Reflection Coefficient (%)	V.S.W.R	Return Loss (dB)	Reflection Coefficient (%)	V.S.W.R	Return Loss (dB)	Reflection Coefficient (%)
1.010	46.06	0.512	1.053	31.80	2.570	1.138	23.80	6.457
1.011	45.60	0.525	1.055	31.40	2.692	1.141	23.60	6.607
1.012	44.80	0.575	1.058	31.00	2.818	1.145	23.40	6.761
1.012	44.20	0.616	1.059	30.80	2.884	1.149	23.20	6.918
1.013	44.00	0.631	1.060	30.71	2.910	1.150	23.13	6.980
1.013	43.60	0.660	1.064	30.20	3.090	1.156	22.80	7.244
1.014	43.00	0.707	1.065	30.00	3.162	1.160	22.60	7.413
1.015	42.80	0.724	1.068	29.60	3.311	1.164	22.40	7.586
1.016	42.40	0.776	1.070	29.40	3.338	1.168	22.20	7.762
1.017	41.60	0.832	1.072	29.20	3.467	1.170	22.12	7.830
1.018	41.20	0.871	1.074	29.00	3.548	1.173	22.00	7.943
1.019	40.60	0.933	1.075	28.80	3.631	1.177	21.80	8.128
1.020	40.08	0.990	1.077	28.40	3.715	1.180	21.66	8.260
1.021	39.80	1.023	1.080	28.30	3.85	1.181	21.60	8.318
1.022	39.40	1.072	1.083	28.00	3.981	1.186	21.40	8.511
1.023	39.00	1.122	1.085	27.80	4.074	1.190	21.23	8.680
1.024	38.60	1.175	1.087	26.70	4.196	1.200	20.83	9.090
1.025	38.20	1.230	1.089	27.40	4.266	1.210	20.08	9.910
1.026	37.60	1.288	1.090	27.32	4.310	1.230	19.73	10.310
1.029	37.00	1.413	1.091	27.20	4.365	1.240	19.40	10.710
1.030	36.59	1.480	1.094	27.00	4.467	1.250	19.08	11.110
1.031	36.40	1.514	1.096	26.80	4.571	1.260	18.48	11.500
1.032	36.00	1.585	1.098	26.60	4.677	1.270	18.49	11.890
1.035	35.40	1.698	1.101	26.40	4.786	1.280	18.22	12.280
1.036	35.00	1.778	1.106	26.00	5.012	1.290	17.95	12.660
1.037	34.80	1.820	1.108	25.80	5.129	1.300	17.69	13.040
1.040	34.19	1.950	1.111	25.60	5.248	1.310	17.45	13.420
1.042	33.80	2.042	1.114	25.40	5.370	1.330	16.98	14.160
1.043	33.60	2.089	1.116	25.20	5.495	1.350	16.54	14.890
1.044	33.40	2.138	1.119	25.00	5.563	1.360	16.33	15.250
1.045	33.20	2.188	1.122	24.80	5.754	1.370	16.13	15.610
1.046	33.00	2.239	1.125	24.60	5.888	1.380	15.94	15.970
1.049	32.40	2.339	1.130	24.29	6.100	1.390	15.75	16.320
1.050	32.20	2.255	1.135	24.00	6.310	1.400	15.60	16.600

RF Total Solution for Wireless Base Station, In building System

LS Cable & System, a global supplier in the wire & cable sector, is now expanding its product portfolio on the wireless communication field to provide total- package solution.

With years of experience serving in one of the most advanced market in the world, LS Cable & System has capability to implement the most efficient solutions based on state of the art technologies on hand,

LS Cable & System is now a RF Total Solution provider to support our customers to meet sophisticated demand of today's fast- evolving technology of wireless communications.

We are determined to support our customers with our leading solution technologies.

Connector 7/16 DIN Series / N Series



Description

RF connector with 7/16 DIN & N interface is typical type for communication systems. LS connectors are designed and produced to have features as below.

- Excellent V.S.W.R Performance
- Low Intermodulation
- Fast and Easy Installation
- Waterproof
- Environment Resistance Ensures Long Life and Consistent Performance

Products Overview

φ	Cable	Cable Description	N Connector		7/16 DIN Connector	
			Male	Female	Male	Female
1/4"	HFSC-FR 6D	Super Flex. 1/4"	CHFS 6NM	CHFS 6NF	CHFS 6DM	CHFS 6DF
			CHFS 6NMR	CHFS 6NFR	CHFS 6DMR	CHFS 6DFR
3/8"	HFSC-FR 10D	Super Flex. 3/8"	CHFS 10NM	CHFS 10NF	CHFS 10DM	CHFS 10DF
			CHFS 10NMR	CHFS 10NFR	CHFS 10DMR	CHFS 10DFR
1/2"	HFSC-FR 12D	Super Flex. 1/2"	CHFS 12NM	CHFS 12NF	CHFS 12DM	CHFS 12DF
			CHFS 12NMR	CHFS 12NFR	CHFS 12DMR	CHFS 12DFR
	HFC-FR 12D	Flex. 1/2"	CHF 12NM	CHF 12NF	CHF 12DM	CHF 12DF
			LHF-FR 12D	CLH 12NM	CLH 12NF	CLH 12DM
7/8"	HFSC-FR 22D	Super Flex. 7/8"	CHFS 22NM	CHFS 22NF	CHFS 22DM	CHF 22DF
			HFC-FR 22D	Flex. 7/8"	CHF 22NM	CHF 22NF
1-1/4"	HFC-FR 33D	Flex. 1-1/4"	CHF 33NM	CHF 33NF	CHF 33DM	CHF 33DF
			LHF-FR 33D	CLH 33NM	CLH 33NF	CLH 33DM
1-5/8"	HFC-FR 42D	Flex. 1-5/8"	CHF 42NM	CHF 42NF	CHF 42DM	CHF 42DF
			LHF-FR 42D	Low Loss 1-5/8"	CLH 42NM	CLH 42NF

* Other Designs are Available on Request

Connector 7/16 DIN Series

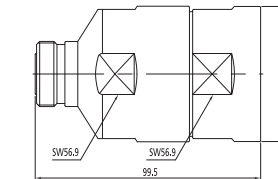

Din-Female for 1-5/8"

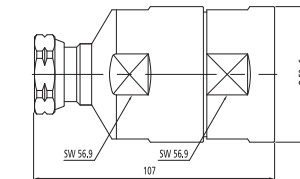

Din-Male for 1-5/8"

Connector Din Type for 1-5/8" LHF & HFAC & HFC

Description	Length (mm)	Max.Dia (mm)	Weight (g)	Code		
				LHF	HFAC	HFC
Din-Female for 1-5/8"	99.5	59.6	1,000	CLH 42DF	CHFA 42DF	CHF 42DF
Din-Male for 1-5/8"	107	59.6	1,070	CLH 42DM	CHFA 42DM	CHF 42DM

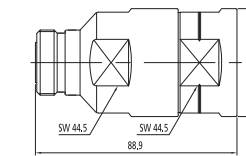

Din-Female for 1-1/4"

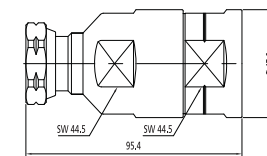

Din-Male for 1-1/4"

Connector Din Type for 1-1/4" LHF & HFC

Description	Length (mm)	Max.Dia (mm)	Weight (g)	Code	
				LHF	HFC
Din-Female for 1-1/4"	88.9	47.6	560	CLH 33DF	CHF 33DF
Din-Male for 1-1/4"	95.4	47.6	560	CLH 33DM	CHF 33DM

Electrical Characteristics

Impedance	50 Ω	
Frequency Range	(Max.) 7.5 GHz	
V.S.W.R	1 GHz (Straight / Right Angle) 1.08 / 1.12	
(Mating)	2 GHz (Straight / Right Angle) 1.10 / 1.15	
Insertion Loss	(Max.) 0.2 dB @ 3 GHz	
IMD	-155dBc	
Dielectric Withstanding Voltage	4.0 kV rms, 50 Hz	
Working Voltage	2.7 kV rms, 50 Hz	
Insulation Resistance	10 G Ω	
Contact Resistance	Inner Contact	0.4 mΩ
	Outer Contact	1.5 mΩ

Mechanical Characteristics

Coupling Nut Torque (Recommended)	25 Nm ~ 30 Nm
Coupling Nut Retention Force	1,000 Nm
Contact Captivation	200 N
Durability (Mating)	500 Times

Connector N Series

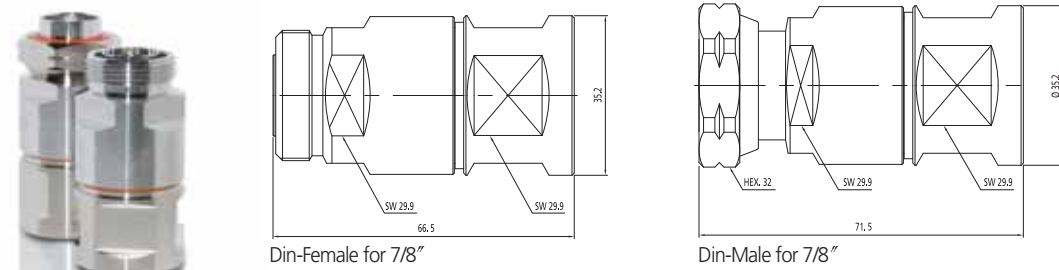

Connector Din Type for 7/8" LHF & HFAC & HFC

Description	Length (mm)	Max.Dia (mm)	Weight (g)	Code		
				LHF	HFAC	HFC
Din-Female for 7/8"	66.5	35.2	210	CLH 22DF	CHF 22DF	CHFS 22DF
Din-Male for 7/8"	71.5	35.2	230	CLH 22DM	CHF 22DM	CHFS 22DM

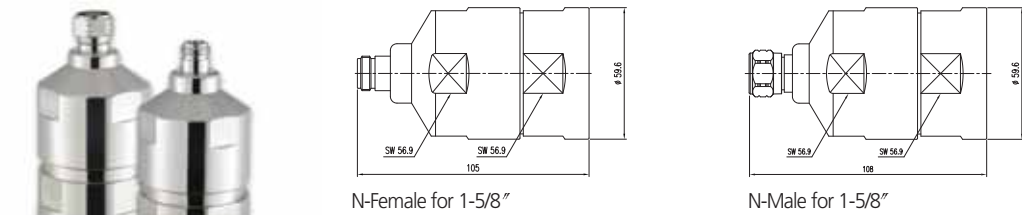

Connector N Type for 1-5/8" LHF & HFAC & HFC

Description	Length (mm)	Max.Dia (mm)	Weight (g)	Code		
				LHF	HFAC	HFC
N-Female for 1-5/8"	105	59.6	1,000	CLH 42NF	CHF 42NF	CHFS 42NF
N-Male for 1-5/8"	108	59.6	1,070	CLH 42NM	CHF 42NM	CHFS 42NM

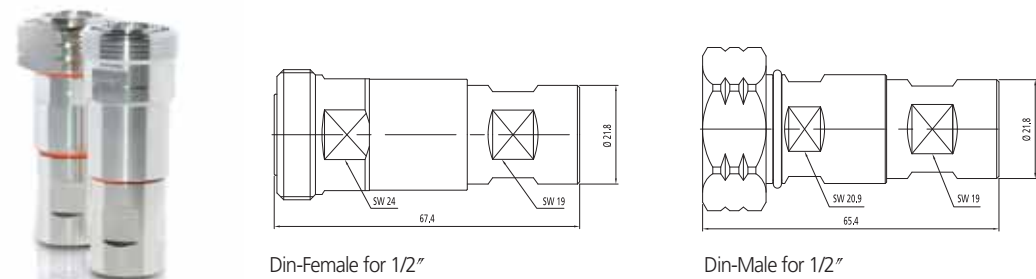

Connector Din Type for 1/2" LHF & HFC & HFSC

Description	Length (mm)	Max.Dia (mm)	Weight (g)	Code		
				LHF	HFC	HFSC
Din-Female for 1/2"	67.4	21.8	150	CLH 12DF	CHF 12DF	CHFS 12DF
Din-Male for 1/2"	65.4	21.8	183	CLH 12DM	CHF 12DM	CHFS 12DM

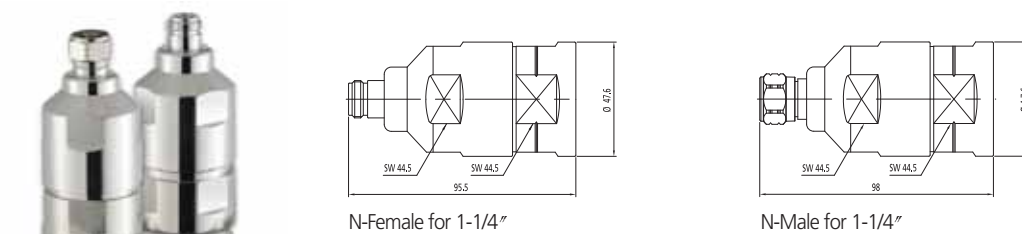

Connector N Type for 1-1/4" LHF & HFC

Description	Length (mm)	Max.Dia (mm)	Weight (g)	Code	
				LHF	HFC
N-Female for 1-1/4"	95.5	47.6	560	CLH 33NF	CHF 33NF
N-Male for 1-1/4"	98	47.6	560	CLH 33NM	CHF 33NM

Environmental Characteristics

Temperature Range	-65 °C ~ +165 °C / -85 °F ~ +329 °F
Corrosion (Salt Spray Test)	IEC-68-2-11-Ka
Vibration	CECC 22000 Part. 4.6.3
Waterproof	IP68

Material Characteristics

Bodies, Cap (Coupling Nut)	Brass / Silver Plated or Su Co (Alloy of Cu/ Sn/ Zn) Plated
Back Nut	Brass / Nickel Plated
Pin	Male Brass / Silver Plated or Su Co (Alloy of Cu/ Sn/ Zn) Plated
	Female Beryllium - Copper / Silver Plated or Su Co (Alloy of Cu/ Sn/ Zn) Plated
Insulators	Fluoroplastic such as PTFE
Gasket	Silicon Rubber

Electrical Characteristics

Impedance	50 Ω	
Frequency Range	(Max.) 11 GHz	
V.S.W.R	1 GHz (Straight / Right Angle)	1.08 / 1.12
	(Mating) 2 GHz (Straight / Right Angle)	1.10 / 1.15
Insertion Loss	(Max.) 0.2 dB @ 3 GHz	
IMD	-155dBc	
Dielectric Withstanding Voltage	2.5 kV rms, 50 Hz	
Working Voltage	1.0 kV rms, 50 Hz	
Insulation Resistance	5,000 m Ω	
Contact Resistance	Inner Contact	1.0 m Ω
	Outer Contact	1.0 m Ω

Mechanical Characteristics

Coupling Nut Torque (Recommended)	0.68 Nm ~ 1.13 Nm
Coupling Nut Retention Force	450 Nm
Contact Captivation	28 N
Durability (Mating)	500 Times

Jumpers Jumper Cable

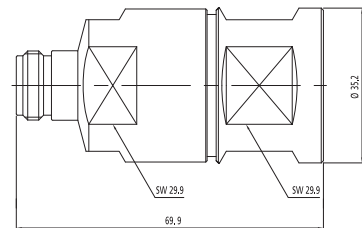

N-Female for 7/8"

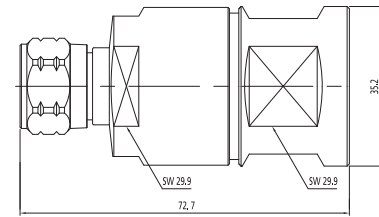

N-Male for 7/8"

Connector N Type for 7/8" LHF & HFAC & HFC

Description	Length (mm)	Max.Dia (mm)	Weight (g)	Code		
				LHF	HFAC	HFC
N-Female for 7/8"	69.9	35.2	215	CLH 22NF	CHF 22NF	CHFS 22NF
N-Male for 7/8"	72.7	35.2	215	CLH 22NF	CHF 22NM	CHFS 22NM



Description

LS Cable & System provides jumper cables which have outstanding electrical performance along with high durability for tight routing and superior environmental sealing for long life reliability.

LS jumper cables are offered in sizes of 3/8" and 1/2". Jumper cables are used in areas that require extremely small bending radius such as on the connection between main feeders and antennas or between main feeders and RF-equipments. LS jumper cables are designed and produced to have features as follows.

Features / Benefits

- High Pull-Off Strength
- Excellent V.S.W.R Performance
 - Typical V.S.W.R Over Cellular, PCS and 3 G-Band are 1.08
- Low and Stable Intermodulation
 - Typical IM3 Product Value with 40 dBm is -155 dBc Over the Cellular and PCS Band
- Complete Weatherproof

Cable Type (Min. Bending Radius)

- HFSC 10D : 25 mm
- HFSC 12D : 35 mm

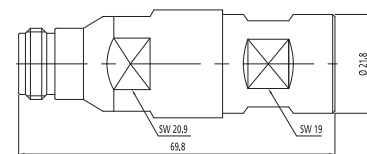

N-Female for 1/2"

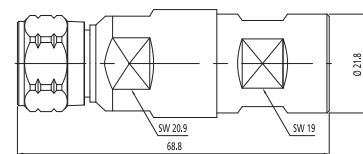

N-Male for 1/2"

Connector N Type for 1/2" LHF & HFC & HFSC

Description	Length (mm)	Max.Dia (mm)	Weight (g)	Code		
				LHF	HFC	HFSC
N-Female for 1/2"	69.8	21.8	115	CLH 12NF	CHF 12NF	CHFS 12NF
N-Male for 1/2"	68.8	21.8	120	CLH 12NM	CHF 12NM	CHFS 12NM

Environmental Characteristics

Temperature Range	-65°C ~ +165°C / -85°F ~ +329°F
Corrosion (Salt Spray Test)	IEC-68-2-11-Ka
Vibration	CECC 22000 Part. 4.6.3
Waterproof	IP68

Material Characteristics

Bodies, Cap (Coupling Nut)	Brass / Silver Plated or Su Co (Alloy of Cu/ Sn/ Zn) Plated
Back Nut	Brass / Nickel Plated
Pin	Male Brass / Silver Plated or Su Co (Alloy of Cu/ Sn/ Zn) Plated
	Female Beryllium - Copper / Silver Plated or Su Co (Alloy of Cu/ Sn/ Zn) Plated
Insulators	Fluoroplastic such as PTFE
Gasket	Silicon Rubber

Accessories Adaptors

Product Code

Description of Attached Connector	HFSC 10D		
	1M	2M	3M
7/16 Male to 7/16 Male	JHFS10-1-DMDM	JHFS10-2-DMDM	JHFS10-3-DMDM
7/16 Male to 7/16 Female	JHFS10-1-DMDF	JHFS10-2-DMDF	JHFS10-3-DMDF
7/16 Female to 7/16 Female	JHFS10-1-DFDF	JHFS10-2-DFDF	JHFS10-3-DFDF
N Male to 7/16 Male	JHFS10-1-NMDM	JHFS10-2-NMDM	JHFS10-3-NMDM
N Female to 7/16 Female	JHFS10-1-NFDF	JHFS10-2-NFDF	JHFS10-3-NFDF
N Male to 7/16 Female	JHFS10-1-NMDF	JHFS10-2-NMDF	JHFS10-3-NMDF
N Female to 7/16 Male	JHFS10-1-NFDM	JHFS10-2-NFDM	JHFS10-3-NFDM
N Male to N Male	JHFS10-1-NMNM	JHFS10-2-NMNM	JHFS10-3-NMNM
N Male to N Female	JHFS10-1-NMNF	JHFS10-2-NMNF	JHFS10-3-NMNF
N Female to N Female	JHFS10-1-NFNF	JHFS10-2-NFNF	JHFS10-3-NFNF

Description of Attached Connector	HFSC 12D		
	1M	2M	3M
7/16 Male to 7/16 Male	JHFS12-1-DMDM	JHFS12-2-DMDM	JHFS12-3-DMDM
7/16 Male to 7/16 Female	JHFS12-1-DMDF	JHFS12-2-DMDF	JHFS12-3-DMDF
7/16 Female to 7/16 Female	JHFS12-1-DFDF	JHFS12-2-DFDF	JHFS12-3-DFDF
N Male to 7/16 Male	JHFS12-1-NMDM	JHFS12-2-NMDM	JHFS12-3-NMDM
N Female to 7/16 Female	JHFS12-1-NFDF	JHFS12-2-NFDF	JHFS12-3-NFDF
N Male to 7/16 Female	JHFS12-1-NMDF	JHFS12-2-NMDF	JHFS12-3-NMDF
N Female to 7/16 Male	JHFS12-1-NFDM	JHFS12-2-NFDM	JHFS12-3-NFDM
N Male to N Male	JHFS12-1-NMNM	JHFS12-2-NMNM	JHFS12-3-NMNM
N Male to N Female	JHFS12-1-NMNF	JHFS12-2-NMNF	JHFS12-3-NMNF
N Female to N Female	JHFS12-1-NFNF	JHFS12-2-NFNF	JHFS12-3-NFNF



Description

RF Adaptor with Between Series & IN - Series is very typical type for communication systems. LS Adaptors are designed and produced to have features as below.

- Excellent V.S.W.R Performance
- Very Low Intermodulation
- Fast and Easy Installation
- Waterproof
- Environment Resistance Ensures Long Life and Consistent Performance

Adaptor type & product code

<Between series>

Product code	Adaptor Type	Gender A	Gender B
AHF NM(F)DM(F)	N / 7/16DIN	Male (Female)	Male (Female)
AHF SM(F)NM(F)	SMA / N	Male (Female)	Male (Female)

<In-series>

Product code	Adaptor Type	Gender A	Gender B
AHF NM(F)NF(M)	N	Male (Female)	Male (Female)
AHF DM(F)DF(M)	7/16DIN	Male (Female)	Male (Female)
AHF SM(F)SF(M)	SMA	Male (Female)	Male (Female)

Electrical Characteristics

Impedance	50 Ω	
Frequency Range	DC to 3 GHz	
V.S.W.R (Max)	1.07:1(DC to 3 GHz)	
Insertion (Max)	-0.1 dB	
Intermodulation Distortion	≤-150dBc (2 ×43dBm carrier)	
Insulation Resistance	≥5 ×10 ⁻³ mΩ	
Dielectric Withstanding	Voltage (at sea level)	2500V rms, 50 Hz
	Working Voltage (at sea level)	≤1000V rms, 50 Hz
Contact Resistance	Center Contact	≤1.0 mΩ
	Outer Contact	≤1.0 mΩ

Environmental Characteristics

Temperature Range	-65°C ~ +165 °C
Temperature Shock	MIL-STD202, Method107, Condition B
Moisture Resistance	MIL-STD202, Method106
Corrosion	Saltspray test acc. To MIL-STD-202 Method101D Condition B
Shock	MIL-STD-202, Method213. Condition I

Surge Arrestor($\lambda/4$ wave)



Description

LS Cable & System's surge arrestors provide excellent lightning protection and outstanding RF performance. All designs have low return loss, low insertion loss and low intermodulation. LS Cable & System offers $\lambda/4$ wave shorting stubs with a full line of mounting adaptors and accessories.

Features / Benefits

- Outstanding RF Performance
- Complete Weatherproof
- Available with Type N or DIN Interface
- Maintenance Free Operation ($\lambda/4$ Wave Shorting Stubs)

Product Code

Model	Code	Frequency Band(MHz)	Interface Type
$\lambda/4$ Wave	AT-NMNF-W	800 ~ 2,700	N-Male / N-Female
	AT-NMNF-01	800 ~ 900	N-Male / N-Female
	AT-NMNF-02	890 ~ 960	N-Male / N-Female
	AT-NMNF-03	1,700 ~ 1,900	N-Male / N-Female

Electrical Characteristics

Model	$\lambda/4$ Wave Shorting Stub
Impedance (Nominal)	50 Ω
V.S.W.R	< 1.1
Insertion Loss	< 0.1 dB
IMD	-155dBc
Max.Impulse Spark-Over Voltage	> 600V

Mechanical Characteristics

Model	$\lambda/4$ Wave Shorting Stub
Outer Conductor	Brass / Silver or SuCo Plated
Inner Conductor	BeCu (Female) / Silver or SuCo Plated
Other Metal Parts	Brass / Nickel Plated
Temperature Range	-40 °C ~ +100 °C
Moisture Resistance	Waterproof

Surge Arrestor(Gas Tube)



Description

LS Cable & System's gas discharge tube type lightning arrestor is one of lightning strike protector that is used most widely with $\lambda/4$ shorting stub type lightning arrestor. The biggest difference from others is that it adapts replaceable gas discharge tube between internal and outer conductor and it discharges electron pulse that occurred instantaneously at lightning strike to earth.

Features / Benefits

- Outstanding Broadband RF Performance (DC~2,700MHz)
- DC Pass Capability
- High Tensional Internal Conductor Structure
- Complete Waterproof
- Available with Type N or 7/16 DIN Type

Product Code

Model	Code	Frequency Band(MHz)	Interface Type
Gas Tube	AG-NMNF-01	DC ~ 2,700	N-Male / N-Female
	AG-DMDF-02	DC ~ 2,700	DIN-Male / DIN-Female

Electrical Characteristics

Model	Gas Tube
Impedance (Nominal)	50 Ω
V.S.W.R	< 1.1
Insertion Loss	< 0.1 dB
Max.Impulse Spark-Over Voltage	> 600V

Mechanical Characteristics

Model	Gas Tube
Outer Conductor	Brass / Silver or SuCo Plated
Inner Conductor	BeCu (Female) / Silver or SuCo Plated
Other Metal Parts	Brass / Nickel Plated
Temperature Range	-40 °C ~ +100 °C
Moisture Resistance	Waterproof

Dummy Load



Description

Dummy load is a means of termination microwave transmission line without much reflection. It is performed by microwave power absorption. Dummy load is used in "RFCL" or "RFCX" application to provide launch for the signal from the end of the cable. All connector interfaces conform to MIL-C-39012. V.S.W.R : 0~3GHz. Max 1.15.

Features / Benefits

- Outstanding RF Performance. Low V.S.W.R
- Available with Type N Interfaces

Product Code

Code	V. S. W. R	Connector Interface	Dummy Load Power Rating
L-DL-10-NM	< 1.15	N-Male	10 Watt
L-DL-10-NF	< 1.15	N-Female	
L-DL-20-NM	< 1.15	N-Male	20 Watt
L-DL-20-NF	< 1.15	N-Female	
L-DL-30-NM	< 1.15	N-Male	30 Watt
L-DL-30-NF	< 1.15	N-Female	
L-DL-50-NM	< 1.15	N-Male	50 Watt
L-DL-50-NF	< 1.15	N-Female	
L-DL-10-DM	< 1.15	DIN-Male	10 Watt
L-DL-10-DF	< 1.15	DIN-Female	
L-DL-20-DM	< 1.15	DIN-Male	20 Watt
L-DL-20-DF	< 1.15	DIN-Female	
L-DL-30-DM	< 1.15	DIN-Male	30 Watt
L-DL-30-DF	< 1.15	DIN-Female	
L-DL-50-DM	< 1.15	DIN-Male	50 Watt
L-DL-50-DF	< 1.15	DIN-Female	

* Note : Other Designs are Available on Request

Cable Cutting Tool



Description

Connector termination is one of the most important factors affecting RF transmission line operation. LS Cable & System offers cable cutting tools in sizes ranging from 1/2" to 1 - 5/8" which are designed to cut the jacket and outer conductor in seconds. These cutting tools make the accurate cuts of cables at top of corrugation at exact distance required for easy connector attachment. It allows to give one more way to ensure consistent electrical performance for your application.

Features / Benefits

- Accurate Termination
- Easy Handling

Product Code

Code	Description	Cable Type
L-CT-12D	Cut Jacket & Outer Conductor	1/2" Flex.
L-CT-12DS	Cut Jacket & Outer Conductor	1/2" Super Flex.
L-CT-22D	Cut Jacket, Outer Conductor, Dielectric & Inner Conductor	7/8" Flex.
L-CT-33D	Cut Jacket, Outer Conductor, Dielectric & Inner Conductor	1-1/4" Flex.
L-CT-42D	Cut Jacket, Outer Conductor, Dielectric & Inner Conductor	1-5/8" Flex.

DC STOP 800~2500MHz

BLK-0822-DMDF



Features

- Low RF Signal Insertion loss
- High DC Signal Isolation from Port1 to Port2 and vice versa
- Suitable for Indoor or Outdoor Applications

Specification

Items	BLK-0822-DMDF
Frequency Range	800 ~ 2,500 MHz
Insertion Loss Port1 ↔Port2	0.1 dB (800 ~ 2,500 MHz)
Isolation Port1 ↔Port2	> 70 dB(DC)
V.S.W.R	1.2
Impedance	50 Ω
Inter Modulation	-160dBc@Tone (2Tone=43dBm)
Input Power	< 750 W (800 ~ 2,500 MHz)

Mechanical

Temperature Range	-20°C ~ +75°C
Connectors	Port1 : 7~16 Male Port2 : 7~16 Female
Weight	0.38
Size	50 x 38 x 37.5 mm 104 x 38 x 37.5 mm (Inc. Connector)

Attenuator

ATT-XdB-002-NMNF / ATT-XdB-002-DMDF



Features

- Wideband Performance DC ~ 3000MHz
- Compact Size
- Low VSWR
- Indoor Applications
- N Connectors
- DIN Connectors

Specification

Items	ATT-XdB-002-NMNF	ATT-XdB-002-DMDF
Frequency Range	DC ~ 3,000 MHz	
Impedance	50 Ω	
V.S.W.R	1.2 : 1	
Attenuation Value	-3, -6, -10, -20 dB ±0.5 dB	-3, -6, -10, -20 dB ±0.5 dB -30 dB ±0.7 dB
Input Power	2W / 10W / 20W	
Connectors	N-Male to N-Female	DIN-Male to DIN-Female
Operating Temperature	-35°C ~ +75°C	
Weight	70 g	280g
Size(without Connectors)	56.8 x Ø 19.0 mm	69.5 x Ø 33 mm

Grounding Kit

Clip-on Type



Description

The standard ground kits facilitate easy installation with a pre-formed copper strap that eliminates the need for a coiling tool and prevents overtightening. These kits are designed to comply with MIL-STD-188-124A and have been verified by independent labs to protect cable from the damaging effects of lightning current in excess of 200 kA. Each kit includes a 5' (1.5m), 6-gauge 7-strand copper ground lead which can be trimmed to the exact length required for a neat and effective installation.

Included in each kit is a two-hole 3/8" (10mm) universal lug, and all hardware necessary for attachment to the buss bar. The innovative two-hole universal lug features a unique slotted design which allows it to accommodate 3/4" to 1" (19mm to 25mm) buss bar hole spacings, ensuring a perfect fit in any ground system. The standard ground kits also include required mastic and electric tape for weatherproofing each kit.

Characteristics

App.	Cable Protection	Mounts to	Cable Outer Conductor
Size	1/2" to 1-5/8" Cable	Material	Copper or Aluminum Strap
Feature	Economical Protection	Incl.	Grounding Kit, Lug, Weatherproofing Kit
Design	Bolt - on Style with 5' (1.5 m) Lead / Crimp Lug		

Product Code

Code	Description	Kit Qty.	Wt. lbs (Wt. kg)
L-GK-C12	Standard Ground Kit for 1/2" Corrugated Cable	Each	1.4 (0.6)
L-GK-C22	Standard Ground Kit for 7/8" Corrugated Cable	Each	1.4 (0.6)
L-GK-C33	Standard Ground Kit for 1-1/4" Corrugated Cable	Each	1.4 (0.6)
L-GK-C42	Standard Ground Kit for 1-5/8" Corrugated Cable	Each	1.5 (0.7)

* Note : 3/8" (10mm) two-hole lugs are universal to accommodate 3/4" to 1" (19mm to 25mm) spacing requirements. Versions of these kits are available with 1/4" (6mm) two-hole lugs or with your choice of lug pre-attached.

Grounding Kit

Easy Install Grounding Kit



Fields of Application

Provides lightning protection on feeder cable and radio equipments with easy installation.

Features

- 304 stainless steel body moulded in EPDM rubber.
- Contact point, tinted braided copper.
- Ground wire, 16mm sq. Copper.
- RoHs comply

Characteristics

Operating Temp. Range	-45 to +85 deg C	Cable Lugs	Tinned, 8mm diameter hole
Contacting Resistance	< 1m ohm	Surge Current	70KA
Cable	16mm sq. (black or green)	Waterproofing	IP68
Cable Length	800mm		

Product Code

Code	Description
L-GK-12-WEI	Easy install grounding kit for 1/2" corrugated cable
L-GK-22-WEI	Easy install grounding kit for 7/8" corrugated cable
L-GK-33-WEI	Easy install grounding kit for 1-1/4" corrugated cable
L-GK-42-WEI	Easy install grounding kit for 1-5/8" corrugated cable

Single Hanger Clamp Set



Description

This single hanger clamp set is a second generation hanger solution designed specially for BTS tower application.

Consist of Set

- Hanger clamp : UV and chemical resistances
- Hardware kits : 10mm 304 stainless steel hardware kit
- Angle adaptor : adaptor bracket, stainless 304

Product Code

Code	Description
L-MT-12SC1	Single Hanger Clamp Set for 1/2" Corrugated Cable 1 Run
L-MT-12SC2	Single Hanger Clamp Set for 1/2" Corrugated Cable 2 Runs
L-MT-12SC3	Single Hanger Clamp Set for 1/2" Corrugated Cable 3 Runs
L-MT-22SC1	Single Hanger Clamp Set for 7/8" Corrugated Cable 1 Run
L-MT-22SC2	Single Hanger Clamp Set for 7/8" Corrugated Cable 2 Runs
L-MT-22SC3	Single Hanger Clamp Set for 7/8" Corrugated Cable 3 Runs
L-MT-33SC1	Single Hanger Clamp Set for 1- 1/4" Corrugated Cable 1 Run
L-MT-33SC2	Single Hanger Clamp Set for 1- 1/4" Corrugated Cable 2 Runs
L-MT-33SC3	Single Hanger Clamp Set for 1-1/4" Corrugated Cable 3 Runs
L-MT-42SC1	Single Hanger Clamp Set for 1- 5/8" Corrugated Cable 1 Run
L-MT-42SC2	Single Hanger Clamp Set for 1- 5/8" Corrugated Cable 2 Runs
L-MT-42SC3	Single Hanger Clamp Set for 1- 5/8" Corrugated Cable 3 Runs



for Small Tower (Max.50m)

Description

This single hanger clamp set for a second generation hanger solution designed specially for BTS tower application.

Consist of Set

- Hanger clamp : UV and chemical resistances
- Hardware kits : 10mm 304 stainless steel hardware kit
- Angle adaptor : adaptor bracket, stainless 304

Product Code

Code	Description
L-MT-12SC1L	Single Hanger Clamp Set for 1/2" Corrugated Cable 1 Run
L-MT-12SC2L	Single Hanger Clamp Set for 1/2" Corrugated Cable 2 Runs
L-MT-12SC3L	Single Hanger Clamp Set for 1/2" Corrugated Cable 3 Runs
L-MT-22SC1L	Single Hanger Clamp Set for 7/8" Corrugated Cable 1 Run
L-MT-22SC2L	Single Hanger Clamp Set for 7/8" Corrugated Cable 2 Runs
L-MT-22SC3L	Single Hanger Clamp Set for 7/8" Corrugated Cable 3 Runs
L-MT-33SC1L	Single Hanger Clamp Set for 1- 1/4" Corrugated Cable 1 Run
L-MT-33SC2L	Single Hanger Clamp Set for 1- 1/4" Corrugated Cable 2 Runs
L-MT-33SC3L	Single Hanger Clamp Set for 1-1/4" Corrugated Cable 3 Runs

* Note : Not available for 1-5/8" corrugated cable

Double Hanger Clamp Set



Description

This double hanger clamp set is a second generation hanger solution designed specially for BTS tower application.

Consist of Set

- Hanger clamp : UV and chemical resistances
- Hardware kits : 10mm 304 stainless steel hardware kit
- Angle adaptor : adaptor bracket, stainless 304

Product Code

Code	Description
L-MT-12DC1	Double Hanger Clamp Set for 1/2" Corrugated Cable 2 Runs
L-MT-12DC2	Double Hanger Clamp Set for 1/2" Corrugated Cable 4 Runs
L-MT-12DC3	Double Hanger Clamp Set for 1/2" Corrugated Cable 6 Runs
L-MT-22DC1	Double Hanger Clamp Set for 7/8" Corrugated Cable 2 Runs
L-MT-22DC2	Double Hanger Clamp Set for 7/8" Corrugated Cable 4 Runs
L-MT-22DC3	Double Hanger Clamp Set for 7/8" Corrugated Cable 6 Runs
L-MT-33DC1	Double Hanger Clamp Set for 1-1/4" Corrugated Cable 2 Runs
L-MT-33DC2	Double Hanger Clamp Set for 1-1/4" Corrugated Cable 4 Runs
L-MT-33DC3	Double Hanger Clamp Set for 1-1/4" Corrugated Cable 6 Runs
L-MT-42DC1	Double Hanger Clamp Set for 1-5/8" Corrugated Cable 2 Runs
L-MT-42DC2	Double Hanger Clamp Set for 1-5/8" Corrugated Cable 4 Runs
L-MT-42DC3	Double Hanger Clamp Set for 1-5/8" Corrugated Cable 6 Runs



for Small Tower (Max.50m)

Description

This double hanger clamp set for small tower which is shorter than 50m height is a second generation hanger solution designed specially for BTS tower application.

Consist of Set

- Hanger clamp : UV and chemical resistances
- Hardware kits : 10mm 304 stainless steel hardware kit
- Angle adaptor : adaptor bracket, stainless 304

Product Code

Code	Description
L-MT-12DC1L	Double Hanger Clamp Set for 1/2" Corrugated Cable 2 Runs Less 50m
L-MT-12DC2L	Double Hanger Clamp Set for 1/2" Corrugated Cable 4 Runs Less 50m
L-MT-12DC3L	Double Hanger Clamp Set for 1/2" Corrugated Cable 6 Runs Less 50m
L-MT-22DC1L	Double Hanger Clamp Set for 7/8" Corrugated Cable 2 Runs Less 50m
L-MT-33DC1L	Double Hanger Clamp Set for 1-1/4" Corrugated Cable 2 Runs Less 50m

* Note : Not available for 7/8" corrugated cable for more then 2 stacks

* Note : Not available for 1-1/4" corrugated cable for more then 2 stacks

* Note : Not available for 1-5/8" corrugated cable

Hoisting Grip

Lace-Up Hoisting Grip / Pre-Laced Hoisting Grip

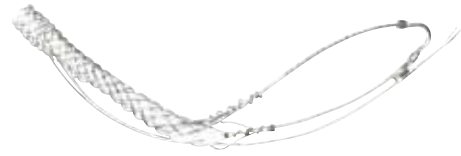

Lace-Up Hoisting Grip

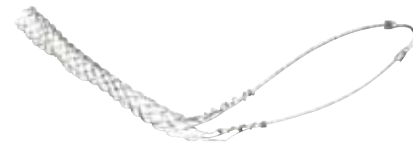

Pre-Laced Hoisting Grip

Description

Lace-up hoisting grips provide an effective means for hoisting cable and elliptical waveguide into position and can be utilized to provide additional support once in place. The lace-up design allows the hoisting grip to be attached even when the run has been connectorized and facilitates easy positioning at 200' (61m) increments on long cable runs. Lace-up hoisting grips for RF cables include a self-locking clip and sealing tape to provide additional support both during and after installation.

Description

Pre-laced hoisting grips feature a closed-mesh design which simplifies installation over traditional split, lace-up style grips. The unique design allows the pre-laced hoisting grip to slip over an unterminated end of cable. The grip securely tightens when pulled, providing an effective means to hoist cable into position and to provide additional support for the cable once in place. Pre-laced hoisting grips for RF cables include a self-locking clip and sealing tape to provide additional support both during and after installation.

Characteristics

	Lace-Up Hoisting Grip	Pre-Laced Hoisting Grip
App.	Cable	Cable Support
Size	1/2" to 1-5/8"	1/2" to 1-5/8"
Feature	Lace-Up Installation at Ant Point On Cable	Pre-Laced to Simplify Installation
Design	Mesh Grip with Single Eye Support	Mesh Grip with Single Eye Support
Material	Tinned Broze	Tinned Bronze
Incl.	Grip, Self-Locking Clip, Tape	Grip, Self-Locking Clip, Tape

Product Code

	Code	Description	Kit Qty.	Wt. lbs/(Wt. kg)
Lace-Up Hoisting Grip	L-HG-12	Open Weave Hoisting Grip for 1/2" Corrugated Cable	Each	0.3 (0.1)
	L-HG-22	Open Weave Hoisting Grip for 7/8" Corrugated Cable	Each	0.6 (0.3)
	L-HG-33	Open Weave Hoisting Grip for 1-1/4" Corrugated Cable	Each	0.6 (0.3)
	L-HG-42	Open Weave Hoisting Grip for 1-5/8" Corrugated Cable	Each	1.3 (0.6)
Pre-Laced Hoisting Grip	L-HG-12L	Open Weave Hoisting Grip for 1/2" Corrugated Cable	Each	0.4 (0.2)
	L-HG-22L	Open Weave Hoisting Grip for 7/8" Corrugated Cable	Each	0.5 (0.2)
	L-HG-33L	Open Weave Hoisting Grip for 1-1/4" Corrugated Cable	Each	0.5 (0.2)
	L-HG-42L	Open Weave Hoisting Grip for 1-5/8" Corrugated Cable	Each	1.3 (0.6)

Generic Locking Cable Blocks

Single and Multi-Stack Version For Round or Flat Members



Description

Utilizing a stainless steel frame to fasten the support blocks in position, the Generic Locking Cable Blocks provide an optimal, low-cost solution for mounting transmission lines to the most commonly used telecom structures.

Its design secures for adaptors or hole drilling. This, combined with the hex head set screw, simplifies installation while minimizing construction costs. The Generic Locking Cable Blocks are designed to attach directly to round and flat members up to 15 millimeters (0.6 inch) thick.

Manufactured from 304 stainless steel and polypropylene, the Generic Locking Cable Blocks provide a cost efficient solution in almost any application.

Characteristics

Code	Description	A(mm/inch)	B(mm/inch)	C(mm/inch)	D(mm/inch)
L-CB-GL06-U1	Generic Locking Cable Blocks for 1/4" Cable, Single Stack, 3 to 12mm, 1/8" to 1/2" Round or Flat	29.21(1.13)	25.40(1.00)	73.03(2.88)	23.81(0.94)
L-CB-GL06-U2	Generic Locking Cable Blocks for 1/4" Cable, Double Stack, 3 to 12mm, 1/8" to 1/2" Round or Flat	57.15(2.25)	25.40(1.00)	101.60(4.00)	23.81(0.94)
L-CB-GL06-U3	Generic Locking Cable Blocks for 1/4" Cable, Triple Stack, 3 to 12mm, 1/8" to 1/2" Round or Flat	85.73(3.38)	25.40(1.00)	130.18(5.13)	23.81(0.94)
L-CB-GL12-U1	Generic Locking Cable Blocks for 1/2" Cable, Single Stack, 3 to 12mm, 1/8" to 1/2" Round or Flat	29.21(1.13)	25.40(1.00)	73.03(2.88)	23.81(0.94)
L-CB-GL12-U2	Generic Locking Cable Blocks for 1/2" Cable, Double Stack, 3 to 12mm, 1/8" to 1/2" Round or Flat	57.15(2.25)	25.40(1.00)	101.60(4.00)	23.81(0.94)
L-CB-GL12-U3	Generic Locking Cable Blocks for 1/2" Cable, Triple Stack, 3 to 12mm, 1/8" to 1/2" Round or Flat	85.73(3.38)	25.40(1.00)	130.18(5.13)	23.81(0.94)
L-CB-GL22-U1	Generic Locking Cable Blocks for 7/8" Cable, Single Stack, 3 to 12mm, 1/8" to 1/2" Round or Flat	38.10(1.50)	25.40(1.00)	82.55(3.25)	36.58(1.44)
L-CB-GL22-U2	Generic Locking Cable Blocks for 7/8" Cable, Double Stack, 3 to 12mm, 1/8" to 1/2" Round or Flat	76.20(3.00)	25.40(1.00)	120.65(4.75)	36.58(1.44)
L-CB-GL22-U3	Generic Locking Cable Blocks for 7/8" Cable, Triple Stack, 3 to 12mm, 1/8" to 1/2" Round or Flat	114.30(4.50)	25.40(1.00)	158.75(6.25)	36.58(1.44)
L-CB-GL33-U1	Generic Locking Cable Blocks for 1-1/4" Cable, Single Stack, 3 to 12mm, 1/8" to 1/2" Round or Flat	52.39(2.06)	25.40(1.00)	95.25(3.75)	47.63(1.88)
L-CB-GL33-U2	Generic Locking Cable Blocks for 1-1/4" Cable, Double Stack, 3 to 12mm, 1/8" to 1/2" Round or Flat	104.78(4.13)	25.40(1.00)	120.65(4.75)	47.63(1.88)
L-CB-GL33-U3	Generic Locking Cable Blocks for 1-1/4" Cable, Triple Stack, 3 to 12mm, 1/8" to 1/2" Round or Flat	157.23(6.19)	25.40(1.00)	146.05(5.75)	47.63(1.88)
L-CB-GL42-U1	Generic Locking Cable Blocks for 1-5/8" Cable, Single Stack, 3 to 12mm, 1/8" to 1/2" Round or Flat	63.50(2.50)	25.40(1.00)	107.95(4.25)	60.45(2.38)
L-CB-GL42-U2	Generic Locking Cable Blocks for 1-5/8" Cable, Double Stack, 3 to 12mm, 1/8" to 1/2" Round or Flat	127.00(5.00)	25.40(1.00)	171.45(6.75)	60.45(2.38)
L-CB-GL42-U3	Generic Locking Cable Blocks for 1-5/8" Cable, Triple Stack, 3 to 12mm, 1/8" to 1/2" Round or Flat	190.50(7.50)	25.40(1.00)	234.95(9.25)	60.45(2.38)

Weatherproofing Kit

Universal Weatherproofing Kit/Cold Shrink Weatherproofing Kit

Universal Weatherproofing kit



Description

The universal weatherproofing kits include mastic and electrical tapes that are applied to provide a multi-layer, long-term environmental seal over multiple connections. The standard version (L-WK-U) includes five 3-3/4" x 2' (95mm x 0.6m) rolls of butyl mastic tape, two 3/4" x 44' (19mm x 13m) rolls of electrical tape, and one 2" x 20' (51mm x 6m) roll of electrical tape. The large version (L-WK-UL) includes five 3-3/4" x 2' (95mm x 0.6m) rolls of butyl mastic tape, three 3/4" x 44' (19mm x 13m) rolls of electrical tape, and three 2" x 20' (51mm x 6m) rolls of electrical tape.

Characteristics

App.	Cable Protection	Design	Tape Kit for Multi-Layer Wrap
Size	Two Versions	Material	Butyl and Winyl
Feature	Multi-Connection Protection	Incl.	See Text

Product Code

Code	Description	Kit Qty.	Wt. lbs (Wt. kg)
L-WK-U	Universal Weatherproofing Kit	Each	3.4 (1.5)

30M™ Cold Shrink™ Weatherproofing Kit



Description

Avoid messy tapes and mastics with cold shrink™. This unique weatherproofing solution installs in less than three minutes, and eliminates difficult and time consuming taping processes. Because no special techniques are required, cold shrink™ can be installed perfectly by both new and experienced installers. To apply, position the kit over a connection, and unwind the spiral support. As the tube loses its support, it collapses over the connection to form a long term environmental seal. An universally designed spacer accommodates similar cable sizes with tolerance variances allowing these kits to be used on a variety of manufacturers RF cables regardless of your cable preference. Cold shrink™ kits are available to seal main feeder, jumper and antenna connections.

Product Code

Splices			Main Feeder to Jumper		
Cable Size	Code	Wt. lbs (Wt. kg)	Cable Size	Code	Wt. lbs (Wt. kg)
1/2" to 1/2"	L-CS-U1212	0.2 (0.1)	7/8" to 1/2"	L-CS-U1222	0.8 (0.4)
7/8" to 7/8"	L-CS-U2222	0.8 (0.4)	1-1/4" to 1/2"	L-CS-U1233	1.0 (0.5)
1-1/4" to 1-1/4"	L-CS-U3333	1.0 (0.5)	1-1/4" to 1-5/8"	L-CS-U3342	1.0 (0.5)
1-5/8" to 1-5/8"	L-CS-U4242	1.0 (0.5)	1-5/8" to 1/2"	L-CS-U1242	1.0 (0.5)

Entry Port System

4"» (102mm) Feed-thru Entry Panel

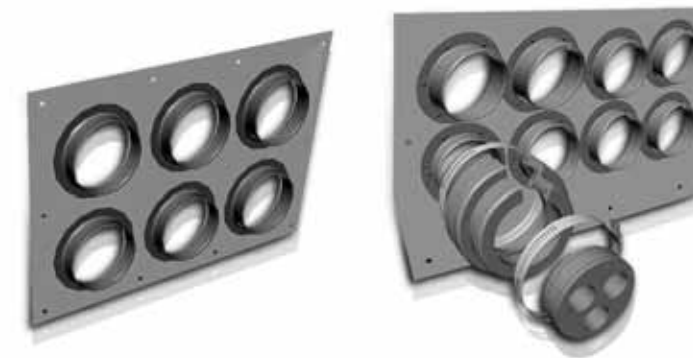

Description

Aluminum feed-thru entry panels enable multiple cable runs to enter buildings and shelters. These rugged panels support the cable at the entry point and prevent moisture from entering the building. Each panel features 4" (102mm) openings to accept boot assemblies. Each boot assembly must be fitted with a cushion to hold the cable in place. Feed-thru entry panels are offered with a broad selection of hole patterns and plate sizes to match your exact application. These entries can be used in both interior and exterior wall applications to create a neat and clean installation. Each feed-thru entry panel includes a set of wall attachment hardware, including #14 x 1-1/2" (6mm x 38mm) stainless steel screws, finishing washers, and plastic anchors and is powder coated to ensure long term integrity and provide appealing aesthetics. Sealing caps for all openings are also included. Boots and cushions, or boot assembly kits must be purchased separately to accommodate specific cable requirements.

Characteristics

App.	Entry Solutions	Mounts to	Walls
Size	19 Sizes	Material	Aluminum
Feature	Easy to Install Solution	Incl.	Port, Caps, Wall Hardware
Design	Entry Plates with Round Ports	Order Sep.	4" (102mm) Boot Assemblies

Product Code

Code	Description	Kit Qty.	Wt. lbs (Wt. kg)	Code	Description	Kit Qty.	Wt. lbs (Wt. kg)
L-EP-220	Entry Panel, 1 Port, 1 x 1, Standard	Each	1.0 (0.5)	L-EP-1338	Entry Panel, 8 Port, 2 x 4, Large	Each	6.0 (2.7)
L-EP-574	Entry Panel, 1 Port, 1 x 1, Compact	Each	0.6 (0.3)	L-EP-1033	Entry Panel, 9 Port, 3 x 3	Each	7.1 (3.2)
L-EP-1448	Entry Panel, 2 Port, 1 x 2	Each	2.3 (1.0)	L-EP-1297	Entry Panel, 10 Port, 2 x 5	Each	7.4 (3.4)
L-EP-1635	Entry Panel, 3 Port, 1 x 3	Each	2.9 (1.3)	L-EP-1118	Entry Panel, 12 Port, 3 x 4, Standard	Each	8.5 (3.9)
L-EP-575	Entry Panel, 4 Port, 1 x 4	Each	3.5 (1.6)	L-EP-1334	Entry Panel, 12 Port, 3 x 4, Compact	Each	7.0 (3.2)
L-EP-1199	Entry Panel, 4 Port, 2 x 2, Standard	Each	4.2 (1.9)	L-EP-1336	Entry Panel, 12 Port, 2 x 6	Each	9.2 (4.2)
L-EP-1650	Entry Panel, 4 Port, 2 x 2, Compact	Each	4.0 (1.8)	L-EP-1447	Entry Panel, 16 Port, 4 x 4	Each	9.0 (4.1)
L-EP-1449	Entry Panel, 6 Port, 2 x 3	Each	6.1 (2.8)	L-EP-1333	Entry Panel, 18 Port, 3 x 6	Each	13.0 (5.9)
L-EP-1477	Entry Panel, 6 Port, 1 x 6	Each	6.0 (2.7)	L-EP-1861	Entry Panel, 20 Port, 4 x 5	Each	11.0 (5.0)
L-EP-576	Entry Panel, 8 Port, 2 x 4, Standard	Each	6.1 (2.8)	L-EP-1340	Entry Panel, 24 Port, 4 x 6	Each	15.8 (7.2)

* Note : 5" (127mm) Feed-thru Entry Panels available with 1, 2, 3, 4, 6, 8, and 9 hole configurations.

Cushion and Boot

4"» (102mm) Boot Assembly Kit



Description

These innovative boot assembly kits feature a boot assembly and standard cushion insert in one convenient package. The unique boot assembly features a split, one-piece design which dramatically reduces installation time and difficulty. Boot assembly kits are designed to be fitted onto EP-series entry panels in wall/roof feed-thru applications.

Characteristics

App.	Entry Solutions	Mounts to	4" (102mm) Entry Panels
Size	Versions for Cable and Elliptical Waveguide	Material	EPDM Rubber
Feature	One-Piece Design Simplifies Installation	Incl.	Boot, Cushion, Two Hose Clamps
Design	Compression Boot Kit for Aluminum Entry Panels	Order Sep.	4" (102mm) Entry Panel

Product Code

Code	Description	Kit Qty.	Wt. lbs (Wt. kg)
L-BA-12-1A	Boot Assembly Kit, 4" (102mm) w/1 Hole for 1/2" Corrugated Cable	Each	1.6 (0.7)
L-BA-12-2A	Boot Assembly Kit, 4" (102mm) w/2 Hole for 1/2" Corrugated Cable	Each	1.6 (0.7)
L-BA-12-3A	Boot Assembly Kit, 4" (102mm) w/3 Hole for 1/2" Corrugated Cable	Each	1.6 (0.7)
L-BA-12-4A	Boot Assembly Kit, 4" (102mm) w/4 Hole for 1/2" Corrugated Cable	Each	1.6 (0.7)
L-BA-12-5A	Boot Assembly Kit, 4" (102mm) w/5 Hole for 1/2" Corrugated Cable	Each	1.6 (0.7)
L-BA-12F-1A	Boot Assembly Kit, 4" (102mm) w/1 Hole for 1/2" Flex Cable	Each	1.6 (0.7)
L-BA-12F-2A	Boot Assembly Kit, 4" (102mm) w/2 Hole for 1/2" Flex Cable	Each	1.6 (0.7)
L-BA-12F-3A	Boot Assembly Kit, 4" (102mm) w/3 Hole for 1/2" Flex Cable	Each	1.6 (0.7)
L-BA-12F-4A	Boot Assembly Kit, 4" (102mm) w/4 Hole for 1/2" Flex Cable	Each	1.6 (0.7)
L-BA-16-1A	Boot Assembly Kit, 4" (102mm) w/1 Hole for 5/8" Corrugated Cable	Each	1.6 (0.7)
L-BA-16-2A	Boot Assembly Kit, 4" (102mm) w/2 Hole for 5/8" Corrugated Cable	Each	1.6 (0.7)
L-BA-16-3A	Boot Assembly Kit, 4" (102mm) w/3 Hole for 5/8" Corrugated Cable	Each	1.6 (0.7)
L-BA-16-4A	Boot Assembly Kit, 4" (102mm) w/4 Hole for 5/8" Corrugated Cable	Each	1.6 (0.7)
L-BA-22-1A	Boot Assembly Kit, 4" (102mm) w/1 Hole for 7/8" Corrugated Cable	Each	1.6 (0.7)
L-BA-22-2A	Boot Assembly Kit, 4" (102mm) w/2 Hole for 7/8" Corrugated Cable	Each	1.6 (0.7)
L-BA-22-3A	Boot Assembly Kit, 4" (102mm) w/3 Hole for 7/8" Corrugated Cable	Each	1.6 (0.7)
L-BA-22-4A	Boot Assembly Kit, 4" (102mm) w/4 Hole for 7/8" Corrugated Cable	Each	1.6 (0.7)
L-BA-33-1A	Boot Assembly Kit, 4" (102mm) w/1 Hole for 1-1/4" Corrugated Cable	Each	1.6 (0.7)
L-BA-42-1A	Boot Assembly Kit, 4" (102mm) w/1 Hole for 1-5/8" Corrugated Cable	Each	1.6 (0.7)
L-BA-57-1A	Boot Assembly Kit, 4" (102mm) w/1 Hole for 2-1/4" Corrugated Cable	Each	1.6 (0.7)

In-Building Passive Product

- Splitter / Tapper
- Coupler
- Combiner
- Hybrid Combiner
- POI

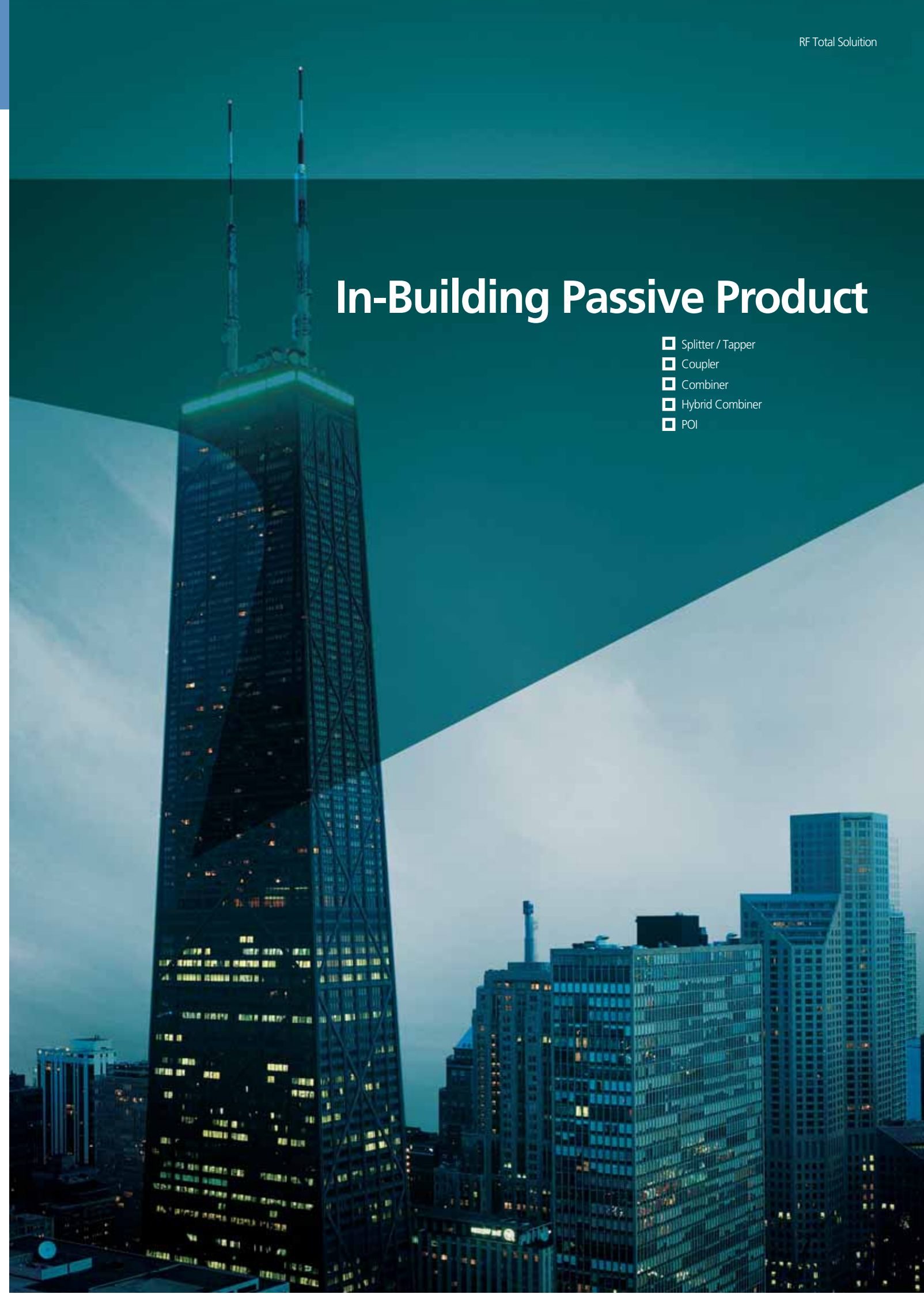

Splitter / Tapper Wide Band Power Splitter(200W)

SPT-2way-100-NF / SPT-3way-100-NF / SPT-4way-100-NF

- Wideband Performance 800 ~ 2700 MHz
- 200 Watt Average Power Rating
- Low Insertion Loss
- Low VSWR
- Low Passive Inter Modulation Products
- Indoor / Outdoor Applications
- N Female Connectors



Common Specification

Items	SPT-2way-100-NF / SPT-3way-100-NF / SPT-4way-100-NF
Frequency Range	800 ~ 2,700 MHz
Impedance	50 Ω
V.S.W.R	< 1.2
Insertion Loss	< 0.1 dB
PIMD (2-tone x 20W)	< -150 dBc
Input Power (avg.)	200 Watt
Connectors	N - Female
Number of Input Port	1
DC - path	All ports
Operating Temperature	-35°C ~ +75°C / 0 ~ 95%
Environmental Class	IP 68

Specification

Model No.	SPT-2way-100-NF	SPT-3way-100-NF	SPT-4way-100-NF
Number of Output Port	2	3	4
Split Loss	3 +/- 0.1 dB	4.8 +/- 0.15 dB	6.0 +/- 0.15 dB
Size	193 x 25 x 25 mm	191 x 25 x 25 mm	193 x 25 x 25 mm
Weight	Approx. 0.4 kg	Approx. 0.45 kg	Approx. 0.5 kg

Splitter / Tapper Wide Band Power Splitter(700W)

SPT-2way-700-NF / SPT-3way-700-NF / SPT-4way-700-NF

- Wideband Performance 800 ~ 2700 MHz
- 700 Watt Average Power Rating
- Low Insertion Loss
- Low VSWR
- Low Passive Inter Modulation Products
- Indoor / Outdoor Applications
- DIN(7/16) Female Connectors



Common Specification

Items	SPT-2way-700-NF / SPT-3way-700-NF / SPT-4way-700-NF
Frequency Range	800 ~ 2,700 MHz
Impedance	50 Ω
V.S.W.R	< 1.2
Insertion Loss	< 0.1 dB
PIMD (2-tone x 20W)	< -150 dBc
Input Power (avg.)	700 Watt
Connectors	7/16 (DIN) - Female
Number of Input Port	1
DC - path	All ports
Size	211 x 40 x 40 mm
Operating Temperature	-35°C ~ +75°C / 0 ~ 95%
Environmental Class	IP 68

Specification

Model No.	SPT-2way-700-NF	SPT-3way-700-NF	SPT-4way-700-NF
Number of Output Port	2	3	4
Split Loss	3 +/- 0.1 dB	4.8 +/- 0.15 dB	6.0 +/- 0.15 dB
Weight	Approx. 1.05 kg	Approx. 1.11 kg	Approx. 1.15 kg

Splitter / Tapper Wide Band Power Tapper(200W)

TAP -7dB-100-NF / TAP -10dB-100-NF
/ TAP -15dB-100-NF

Features

- Wideband Performance 800 ~ 2700 MHz
- 200 Watt Average Power Rating
- Low Insertion Loss
- Low VSWR
- Low Passive Inter Modulation Products
- Indoor / Outdoor Applications
- N Female Connectors



Common Specification

Items	TAP -7dB-100-NF / TAP -10dB-100-NF / TAP -15dB-100-NF
Frequency Range	800 ~ 2,700 MHz
Impedance	50 Ω
V.S.W.R	< 1.4
Insertion Loss	< 0.1 dB
PIMD (2-tone x 20W)	< -150 dBc
Input Power (avg.)	200 Watt
Connectors	N - Female
Number of Input Port	1
Number of /output Port	2
DC - path	All ports
Size	184 x 25 x 25 mm
Weight	Approx. 0.4 kg
Operating Temperature	-35°C ~ +75°C / 0 ~ 95%
Environmental Class	IP 68

Specification

Model No.	TAP -7dB-100-NF	TAP -10dB-100-NF	TAP -15dB-100-NF
Tap Loss (Input - P1)	-7 +/- 1.0 dB	-10 +/- 1.0 dB	-15 +/- 1.0 dB
Tap Loss (Input - P2)	< 1.3 dB	< 0.7 dB	< 0.4 dB

Coupler Wide Band Directional Coupler

CPL-100-6dB-NF / CPL-100-8dB-NF / CPL-100-10dB-NF
CPL-100-13dB-NF / CPL-100-15dB-NF / CPL-100-20dB-NF
CPL-100-30dB-NF

Features

- Wideband Performance 800 ~ 2700 MHz
- 100 Watt Average Power Rating
- Low Insertion Loss
- Low VSWR
- Low Passive Inter Modulation Products
- Compact Size
- Indoor Applications
- N Female Connectors



Common Specification

Items	Wideband Directional Coupler
Frequency Range	800 ~ 2,700 MHz
Impedance	50 Ω
V.S.W.R	< 1.2
Directivity	> 20 dB
PIMD (2-tone x 20W)	< -150 dBc
Input Power (avg.)	100 Watt (Forward Input, All Port Terminated)
Connectors	N - Female
Operating Temperature	-33°C ~ +75°C / 0 ~ 95%
Weight	0.3 kg
Size	108.4 x 29.2 x 23 mm

Specification

Model No.	CPL-100-6dB-NF	CPL-100-8dB-NF	CPL-100-10dB-NF	CPL-100-13dB-NF
Tap Loss (Input - P1)	-6 +/- 0.8 dB	-8 +/- 0.8 dB	-10 +/- 0.8 dB	-13 +/- 1.0 dB
Tap Loss (Input - P2)	< 1.5 dB	< 1.1 dB	< 0.7 dB	< 0.5 dB

Model No.	CPL-100-15dB-NF	CPL-100-20dB-NF	CPL-100-30dB-NF
Tap Loss (Input - P1)	-15 +/- 1.0 dB	-20 +/- 1.0 dB	-30 +/- 1.0 dB
Tap Loss (Input - P2)	< 0.4 dB	< 0.2 dB	< 0.2 dB

Combiner Dual Band Combiner

DBC-0822-3D / DBC-0822-3F

Features

- Integrates Wireless Bands (806 MHz~960 MHz & 1920 MHz~2170 MHz)
- Designed for Co-Site Systems
- Available as a Single Unit or Double Unit
- Wall or Pole Mounting
- Reciprocal Characteristic
- Low Insertion Loss
- Low Passive Inter Modulation Products
- Indoor / Outdoor Applications
- 7/16(Din) Female Connectors



Common Specification

Items	DBC-0822-3D / DBC-0822-3F
Frequency Range	Band1 : 806 ~ 960 MHz / Band2 : 1710 ~ 2170 MHz
Impedance	50 Ω
VSWR	1.2 : 1
Insertion Loss	
Port1 ↔ Port3	< 0.15 dB Typ. (806 ~ 960 MHz)
Port2 ↔ Port3	< 0.25 dB Typ. (1710 ~ 2170 MHz)
Isolation Loss	
Port1 ↔ Port2	< -45 dB (806 ~ 824 MHz) < -50 dB (1710 ~ 2170 MHz)
PIMD	< -150dBc
Input Power (avg.)	250 Watt
Mounting	Wall
Connectors	7/16(DIN) – Female
Environmental Class	IP 65
Operating Temperature	-40°C ~ +60°C
Weight	1.6 kg
Size(with Bracket)	210 x 129 x 42mm

Specification

Model No.	DBC-0822-3D	DBC-0822-3F
DC Pass	Band 1 : DC Pass / Band 2 : DC Pass	Band 1 : DC Block / Band 2 : DC Pass

Combiner Triple Band Combiner

TBC-0822-4A / TBC-0822-4D

Features

- High Isolation Cross Band
- Minimal Insertion Loss
- High "Q" Value Design
- Compact Size & Low Weight
- 240W High Power Rating
- Indoor or Outdoor Application
- Low Passive Intermodulation
- High Reliability
- 7/16(Din) Connector & N Connector
- Co-Site System
- Integrates CDMA800 / GSM900 & GSM & UMTS



Common Specification

Items	TBC-0822-4A / TBC-0822-4D		
	806 ~ 960 MHz (CDMA800, GSM900)	1710 ~ 1880 MHz (GSM1800)	1920 ~ 2170 MHz (UMTS)
Frequency Range			
Insertion Loss(Max.)	0.2 dB	0.4 dB	0.4 dB
VSWR	1.2:1		
Isolation(Min.)	> 50 dB (1710 ~ 1880) > 50 dB (1920 ~ 2170)	> 50 dB (806 ~ 960) > 50 dB (1920 ~ 2170)	> 50dB (806 ~ 960) > 50dB (1710 ~ 1880)
Intermodulation Products @2-tone * 20w[dBc]	< -160 dBc		
Connectors	7/16(DIN)-Female		
Operating Power	240W Avg.		
Application	(Indoor or Outdoor) IP 66		
Mounting	Wall Mounting, Mast Mounting		
Size	242 x 216 x 65 mm		
Operating Temperature	-40°C ~ +60°C		

Specification

Model No.	TBC-0822-4A	TBC-0822-4D
DC Pass	DC Block	DC By-Pass

Hybrid Combiner 3dB Hybrid Combiner

CPL-100-3-DF-B / CPL-100-3-NF-B

Features

- Wideband Performance 800 ~ 2700 MHz
- High Isolation
- 120 Watt Average Power Rating
- Low Insertion Loss
- Low VSWR
- Low Passive Inter Modulation Products
- Compact Size
- Indoor / Outdoor Applications
- 7/16(Din) or N Female Connectors



Common Specification

Items	CPL-100-3-DF-B / CPL-100-3-NF-B
Frequency Range	800 ~ 2,700 MHz
Impedance	50 Ω
V.S.W.R	1.2:1
Coupling Value	3.0 +/- 0.6 dB
Isolation	< -23 dB
PIMD (2-tone x 20W)	< -150 dBc
Input Power (avg.)	120 W
Operating Temperature	-35°C ~ +75°C
Environmental Class	IP 68

Specification

Model No.	CPL-100-3-DF-B	CPL-100-3-NF-B
Connectors	7/16 (DIN) - Female	N - Female
Size (without Connector)	129 x 42 x 40 mm	129 x 44 x 31.5 mm
Weight	940 g	650 g

Hybrid Combiner 4 x 4 Hybrid Combiner(Square Type)

MUL-0827-44A

Features

- Wideband Performance 800 ~ 2700 MHz
- Co-Site System
- High Isolation
- 100 Watt Average Power Rating
- Low Insertion Loss
- Low VSWR
- Low PIMD
- Compact Size
- Indoor / Outdoor Applications
- 7/16(Din) or N Female Connectors



Common Specification

Items	MUL-0827-44A / MUL-0827-44B
Frequency Range	800 ~ 2,700 MHz
Impedance	50 Ω
V.S.W.R	1.2:1
Coupling Value	6.2 +/- 0.8dB
Isolation	< -25 dB
PIMD (2-tone x 20W)	< -150 dBc
Input Power (avg.)	100 Watt
Operating Temperature	-20°C ~ +75°C / 0 ~95%
Environmental Class	IP 68

Specification

Model No.	MUL-0827-44A	MUL-0827-44B
Connectors	N - Female	7/16 (DIN) - Female
Size (without Connector)	150.4 x 150.4 x 28.4 mm	153 x 153 x 35 mm
Weight	1.85 kg	2.6 kg

4 x 4 Hybrid Combiner(Oblong Type)

MUL-0827-44C / MUL-0827-44D

Features

- Wideband Performance 800 ~ 2700 MHz
- Co-Site System
- High Isolation
- 100 Watt Average Power Rating
- Low Insertion Loss
- Low VSWR
- Low PIMD
- Compact Size
- Indoor / Outdoor Applications
- 7/16(Din) or N Female Connectors



Common Specification

Items	MUL-0827-44C / MUL-0827-44D
Frequency Range	800 ~ 2,700 MHz
Impedance	50 Ω
V.S.W.R	1.3:1
Coupling Value	6.2 +/- 0.8 dB
Isolation	< -20 dB
PIMD	< -150 dBc
Input Power (avg.)	100 W
Operating Temperature	-20°C ~ +75°C / 0 ~95%
Environmental Class	IP 68

Specification

Model No.	MUL-0827-44C	MUL-0827-44D
Connectors	N - Female	7/16 (DIN) - Female
Size (without Connector)	247.6 x 90.4 x 36 mm	267.6 x 90.4 x 40 mm
Weight	2.4 kg	2.8 kg

Multi Operator Combiner(GSM900 x 1, GSM1800 x 2, UMTS x 3)

SBC-0822-8A

Features

- High Isolation Cross Band
- Minimal Insertion Loss
- High "Q" Value Design
- Use for Co-site System
- Low Passive Intermodulation
- Permit Combining of GSM900, GSM1800 x 2, UMTS x 3
- Compact Size in Wall Mount or "19" Format Makes Installation Easy



Specification

Items	SBC-0822-8A				
Frequency Range	GSM900	Up	890.0~915.0 MHz		
		Down	935.0~960.0 MHz		
	GSM1800	Up	1725.0~1750.0 MHz	1760.0~1770.0 MHz	
		Down	1820.0~1845.0 MHz	1855.0~1865.0 MHz	
	UMTS	Up	1920.3~1935.1 MHz	1964.9~1979.7 MHz	1935.1~1950.1 MHz
		Down	2110.3~2125.1 MHz	2154.9~2169.7 MHz	2125.1~2140.1 MHz
Insertion Loss	GSM900	< 0.7 dB			
	GSM1800	< 2.0 dB			
	UMTS	< 7.0 dB			
Isolation	Between Same System	> 30 dB			
	Between Same System	> 65 dB			
Return Loss	> 18 dB				
Impedance	50 Ω				
Input Power Rating Per Port	60 W				
Monitor Port Coupling Value	30 ± 2.0 dB				
Temperature Range	0°C ~ +60°C				
Environmental Class	IP 56				
Mounting	19" Rack				
Weight	22 kg				
Connectors	N-Type (Female)				
Size	482 x 460 x 266 mm				

Multi Operator Combiner(GSM900 x 2, GSM1800 x 3, UMTS x 3)

MBC-0822-14A

Features

- High Isolation Cross Band
- Minimal Insertion Loss
- High "Q" Value Design
- Use for Co-site System
- Low Passive Intermodulation
- Permit Combining of GSM900 x 2, GSM1800 x 3, UMTS x 3
- Compact Size in Wall Mount or (19" Format Optional)
- Makes Installation Easy



Specification

Items		Operator 1	Operator 2	Operator 3	Operator 4	
Frequency Range	IDEN	Up	806~825 MHz			
		Down	851~870 MHz			
	EGSM	Up			880~890 MHz	
		Down			925~935 MHz	
	GSM900	Up		900~915 MHz	890~900 MHz	
		Down		945~960 MHz	935~945 MHz	
GSM1800	Up		1710~1730 MHz	1760~1780 MHz	1740~1760 MHz	
	Down		1805~1825 MHz	1855~1875 MHz	1835~1855 MHz	
UMTS	Up		1935.1~1950.1 MHz	1950.1~1964.9 MHz	1920.0~1935.1 MHz	
	Down		2125.1~2140.1 MHz	2140.1~2154.9 MHz	2110.3~2125.1 MHz	
Insertion Loss			< 5.5 dB			
Between Same System Isolation	IDEN / GSM900 / GSM1800		> 22 dB			
	UMTS		> 33 dB			
Between Different System Isolation	IDEN - EGSM / GSM900		> 40 dB			
	IDEN - GSM1800 / UMTS		> 91 dB			
	EGSM / GSM900 - GSM1800 / UMTS		> 91 dB			
	GSM1800 - UMTS		> 91 dB			
Return Loss	Input Port		> 20 dB			
	Output		> 6 dB			
Impedance			50 Ω			
Input Power Rating Per Port			100 W / IDEN : 150W			
3rd PIMD	@2 x 43dBm		> 155 dBc			
Monitor Port Coupling Value			30 ±2.0 dBc			
Temperature Range			0°C ~ +75°C			
Mounting			Wall mount (Optional 19" Rack)			
Environmental Class			IP 65 (Only wall mount)			
Weight			35 kg			
Connectors	Input / Output		7-16 DIN – Female (N-Female Optional) :12port			
	Coupling Port		N-Female : 2port			
Size			650 x 591 x 319 mm (Include mounting)			

Multi Operator Combiner(GSM1800 x 6, WCDMA x 6)

MBC-1822-18A

Features

- Minimal Insertion Loss
- High "Q" Value Design
- Use for Co-site System
- Low PIMD
- Permit Combining of GSM1800 x 6, WCDMA x 6, Sector Output $\alpha \times 2, \beta \times 2, \gamma \times 2,$
- Compact Size in Wall Mount or "19" Format



Specification

Items		Operator 1	Operator 2	Operator 3
Frequency Range	GSM1800	Up	1710~1785 MHz	1710~1785 MHz
		Down	1805~1880 MHz	1805~1880 MHz
	WCDMA	Up	1920~1980 MHz	1920~1980 MHz
		Down	2110~2170 MHz	2110~2170 MHz
Insertion Loss			< 4.5 dB	
Between Same System Isolation	GSM1800 - GSM1800		> 20 dB	
	WCDMA - WCDMA		> 20 dB	
Between System Isolation	GSM1800 - WCDMA		> 40 dB	
Return Loss			> 18 dB	
Impedance			50 Ω	
Input Power Rating Per Port			100 W	
3rd PIMD	@2 x 43dBm		> 140 dBc	
Temperature Range			-10°C ~ +60°C	
Mounting			19" Rack, Wall mount	
Weight			25 kg (Approximate)	
Connectors			N-Female	
Size			437 x 330 x 270 mm (Approximate)	

MBC-0822-18B



Features

- High Isolation Cross Band
- Minimal Insertion Loss
- High "Q" Value Design
- Use for Co-site System
- Low Passive Intermodulation
- Permit Combining of CDMA x 3, GSM900 x 2, GSM1800 x 3 and UMTS x 4
- Compact Size
- Makes Installation Easy

Specification

Items		Operator 1	Operator 2	Operator 3	Operator 4	
Frequency Range	CDMA	Up	824~849 MHz	824~849 MHz	824~849 MHz	
		Down	870~879 MHz	870~894 MHz	870~894 MHz	
	GSM900	Up	897.5~915 MHz	897.5~915 MHz		
		Down	942.5~960 MHz	942.5~960 MHz		
	GSM1800	Up	1710~1785 MHz		1710~1785 MHz	1710~1785 MHz
		Down	1805~1880 MHz		1805~1880 MHz	1805~1880 MHz
WCDMA	Up	1920~1980 MHz	1920~1980 MHz	1920~1980 MHz	1920~1980 MHz	
	Down	2110~2170 MHz	2110~2170 MHz	2110~2170 MHz	2110~2170 MHz	
Insertion Loss	CDMA / GSM900			< 8.5 dB		
	GSM1800 / WCDMA			< 7.5 dB		
Between Same System Isolation	CDMA / GSM900 / GSM1800 / WCDMA			> 20 dB		
Between System Isolation	CDMA ↔ GSM900, GSM1800, WCDMA			> 50 dB		
	GSM900 ↔ CDMA, GSM1800, WCDMA			> 50 dB		
	GSM1800 ↔ CDMA, GSM900, WCDMA			> 50 dB		
	WCDMA ↔ CDMA, GSM900, GSM1800			> 50 dB		
Return Loss	Input Port			> 18 dB		
	Output			> 14 dB		
Impedance				50 Ω		
Input Power Rating Per Port				100 W		
3rd PIMD	@2 x 43 dBm			< -150 dBc		
Monitor Port Coupling Value				30 ±2.0 dBc		
Temperature Range				-10°C ~ +60°C		
Mounting				19" Rack, Wall mount		
Weight				35 kg		
Connectors	BTS / ANT Ports		16port : 7-16 DIN - Female			
	Coupling Ports		2port : N-Female			
Size				482 x 460 x 266 mm		

GLOBAL NETWORK

More than 60 Factories,
Sales and Production Sites
in 20 Countries.

- Factory
- Sales office
- Branch office



KOREA



Gumi Plant
EHV / MV / LV cable
UTP, RF cable
SCR, Magnet wire
Overhead cable, Bus duct



Indong Plant
Optical fiber
Optical cable



Donghae Plant
Submarine cable
Industrial specialty cable

CHINA



LSHQ(Yichang)
EHV / MV / LV cable
Industrial specialty cable



LSCW(Wuxi)
Industrial devices cable
Automotive cable
Harness & module
Aluminum, Bus duct

VIETNAM



LS-VINA(Haiphong)
EHV / MV / LV cable
SCR, ACSR
Overhead cable



LSCV(HO Chi Minh)
MV / LV cable
UTP, Optical cable
Overhead cable

INDIA



LSCI(Bawal)
EHV / MV / LV cable
RF cable
Overhead cable

USA



LSCUS(Tarboro)
MV / LV cable
Control, Instrument cable

POLAND



LS EV Poland./LSCP (Dzierzoniow)
Automotive battery components
Optical cable



www.lscns.com

LS RF Feeder System & Accessories

19F, LS Yongsan Tower, 92, Hangang-daero, Yongsan-gu, Seoul, 04386, Korea
Tel. 02-2189-9231/9328 Fax. 02-2189-9259

©2020 LS Cable & System Ltd. All right reserved.

This product or document is protected by copyright and distributed under licenses restricting its use, copying, distribution, and recompilation. No part of this product or document may be reproduced in any form by any means without prior written authorization of LS Cable&System and its licensors, if any.

Products shown on this catalog are subject to change without any prior notice.